

80911

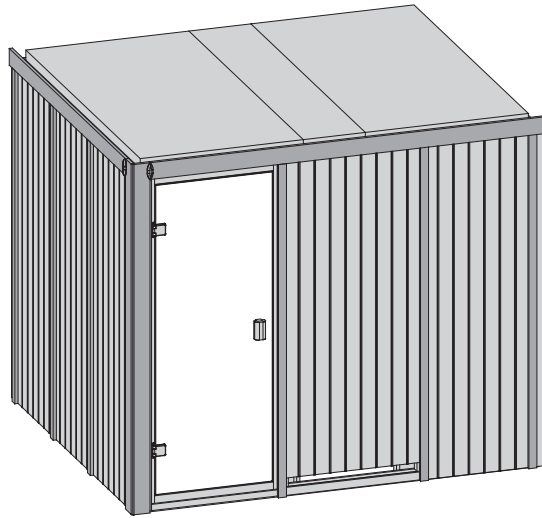

 **Aufbauanleitung**

 **Building Instructions**

 **notice de montage**

 **montagehandleiding**

 **Montagevejledning**

 **Instrucciones de construcción**

 **Istruzioni per il montaggio**

 **Montážní návod**

Bitte bewahren Sie die Anleitung und den Garantieschein zur Seriennummer auf.





Vernichten Sie diese erst nach Ablauf der Garantiezeit.

Eventuelle Beanstandungen können mithilfe der Stückliste einfacher zugeordnet werden.





Beigelegte Dokumente

- Informationsheft
- Garantieschein zur Seriennummer
- Typenschild inkl. Warnhinweise (Sauna)
- ggf. Zubehör-Anleitungen in externen Paketen





- *  Nicht im Lieferumfang enthalten
 Not included
 Non comprises dans la livraison
 Niet bijgeleverd

-  No forman parte del suministro
 Non incluso
 V ceně není zahrnuto
 Ikke inkluderet

- 1  Länge muss ermittelt und zugesägt werden
 Length must be determined and sawn
 La longueur doit être déterminée et sciée
 De lengte moet worden bepaald en worden gezaagd

-  La longitud debe ser determinada y aserrada
 La lunghezza deve essere determinata e segata
 Délka musí být určena a rozřezána
 Længden skal bestemmes og saves





- 2  Nicht gebraucht
 Not needed
 Pas nécessaire
 Niet nodig

-  No es necesario
 Non necessario
 Není nutná
 Ikke nødvendigt





- 3  Mit Zubehör
 With accessories
 Avec accessoires
 Met toebehoren

-  Con accesorios
 Con accessori
 S příslušenstvím
 Med tilbehør

- 4  Fixiert vorübergehend
 Fixed temporarily
 Temporairement fixe
 Tijdelijk vast

-  Temporalmente fijo
 Temporaneamente fisso
 Dočasně pevný
 Midlertidigt rettet

- 5  Bestand vom Haus
 Inventory of the house
 Inventaire de la maison
 Inventaris von het huis

-  Inventario de la casa
 Inventario della casa
 Inventář domu
 Inventar af huset

Werkzeuge / Tools*

X

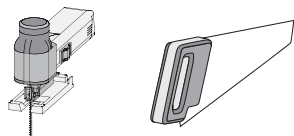

X

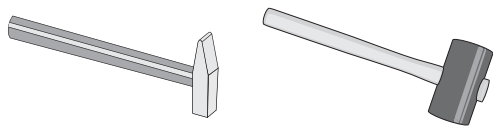

X

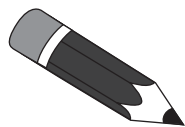

X

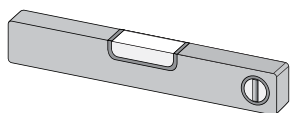

X

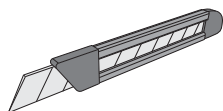

X

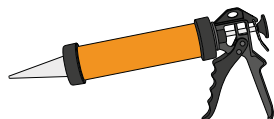
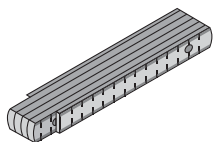

X

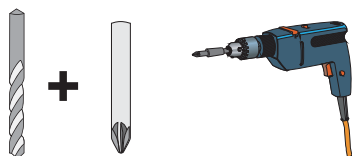

X

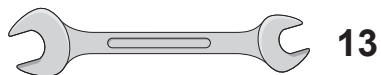

X

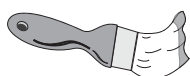

X



Technische Daten

In der Auftragsbestätigung bzw. Lieferschein ist der gekaufte Ofentyp bzw. das erworbene Steuergerät zu finden. Bitte entnehmen Sie die technischen Daten Ihrer Geräte der folgenden Auflistung

Gerät	Netzspannung	Wattage
Öfen		
9kW Ofen Bio	400V ~ 3N	9kW
9kW Ofen (Finnisch)	400V ~ 3N	9kW
9kW Ofen integr. Steuerung	400V ~ 3N	9kW
4,5kW Ofen Bio	400V ~ 3N	4,5kW
4,5kW Ofen (Finnisch)	400V ~ 3N	4,5kW
4,5kW Ofen integr. Steuerung	400V ~ 3N	4,5kW
3,6kW Ofen Bio	230V ~ 1N	3,6kW
3,6kW Ofen (Finnisch)	230V ~ 1N	3,6kW
3,6kW Ofen integr. Steuerung	230V ~ 1N	3,6kW
Steuergeräte		
externe Steuerung Easy Bio	400V ~ 3N	max. 10,8kW
externe Steuerung Plug&Play Bio	240V ~ 3N	max. 10,8kW
externe Steuerung (Finnisch)	400V ~ 3N	max. 10,8kW
externe Steuerung Plug&Play (Finnisch)	240V ~ 3N	max. 10,8kW
Multisteuergerät	400V ~ 3N	max. 10,5kW
externe Steuerung Classic Bio	400V ~ 3N	max. 9kW
externe Steuerung Classic (Finnisch)	400V ~ 3N	max. 9kW
externe Steuerung Premium Bio	400V ~ 3N	max. 12kW
externe Steuerung Premium (Finnisch)	400V ~ 3N	max. 9kW



Vergleichen Sie zuerst die Materialliste mit Ihrem Paketinhalt! Bitte haben Sie Verständnis, dass Beanstandungen nur im nicht aufgebauten Zustand bearbeitet werden können!



Vergelijk eerst de lijst van materialen met de inhoud van uw pakket! Reclamaties kunnen alleen in behandeling worden genomen zolang de onderdelen nog niet zijn gemonteerd!



Confrontate questa distinta materiali prima con il contenuto del pacchetto! Vi preghiamo di comprendere che eventuali reclami possono essere accolti solo prima del montaggio!



First compare the list of materials with your package contents! Please understand that complaints can be processed in the non-built status only!



Start med at kontrollere materialelisten med indholdet af den leverede pakke! Vi gør venligst opmærksom på at reklamationer kun kan behandles for materialer som ikke er blevet bearbejdet!



Nejprve přezkontrolujte obsah balení podle materiálového listu! Mějte pochopení pro to, že případnou reklamaci se můžeme zabývat pouze tehdy, když díly nebudou smontované! Za pomoci tohoto seznamu můžete jednotlivé díly přiřadit k montážnímu návodu.



Commencez par comparer la liste du matériel avec le contenu de votre paquet! Sachez que nous traitons uniquement les réclamations concernant le matériel à l'état non monté!



En primer lugar, compare la lista de material con el contenido del paquete. Rogamos entienda que las reclamaciones sólo pueden ser tramitadas antes de montar el objeto!

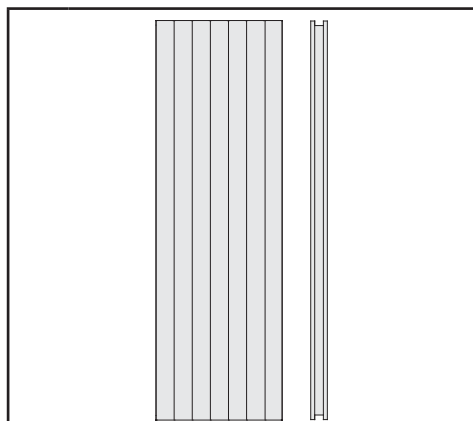
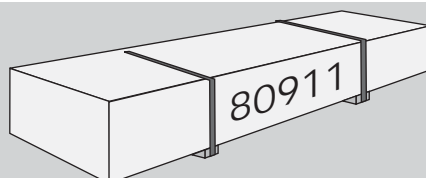

4 x W1 | 1920 x 606 x 68 mm | ID 25548

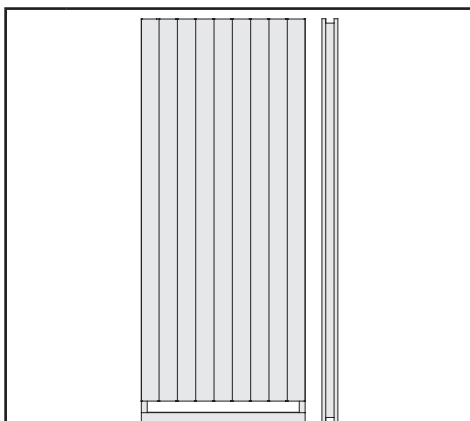

1 x W2 | 1920 x 780 x 68 mm | ID 24677

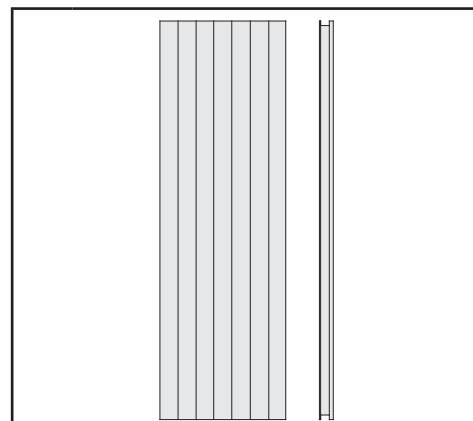

3 x W3 | 1920 x 606 x 57 mm | ID 23624

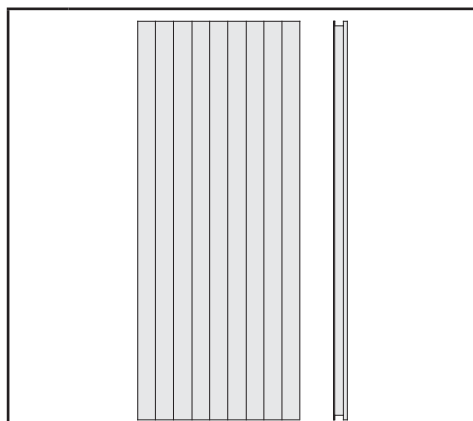

2 x W4 | 1920 x 780 x 57 mm | ID 23625

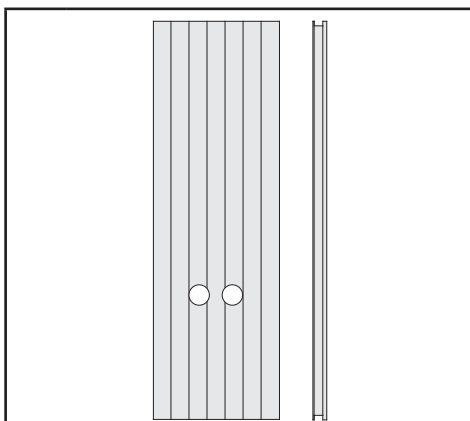

1 x W5 | 1920 x 606 x 57 mm | ID 23629

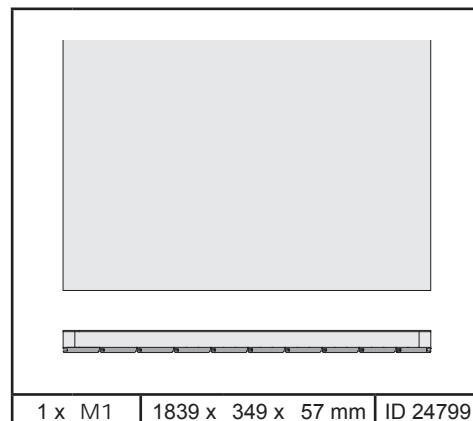

1 x M1 | 1839 x 349 x 57 mm | ID 24799
2 x M2 | 1839 x 918 x 57 mm | ID 45230

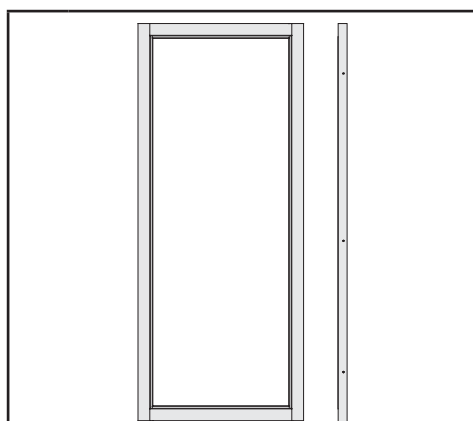

1 x X1 | | ID 26499

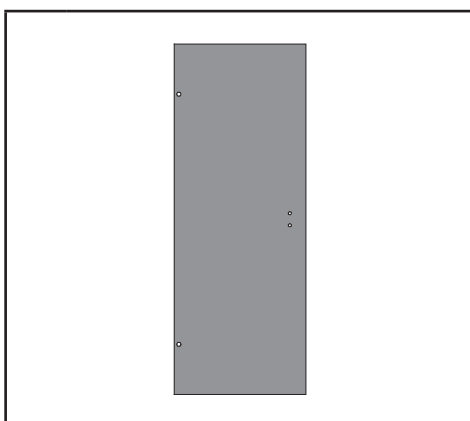

1 x X2 | | ID 26494

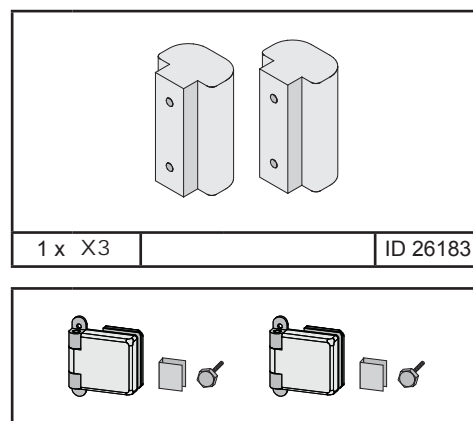

1 x X3 | | ID 26183

1 x X4 | | ID 26496

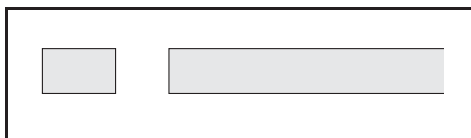

9 x B1	1920 x 19 x 3 mm	ID 20799
4 x B2	750 x 36 x 12 mm	ID 24239
4 x B3	1920 x 36 x 12 mm	ID 24846
6 x B4	1884 x 45 x 17 mm	ID 48037
4 x B5	70 x 45 x 18 mm	ID 26366
4 x B6	800 x 45 x 18 mm	ID 24796
4 x B7	480 x 95 x 18 mm	ID 20930
4 x B8	580 x 95 x 18 mm	ID 16708
2 x B9	2245 x 95 x 18 mm	ID 26369
1 x B10	300 x 120 x 18 mm	ID 22467
1 x B11	540 x 42 x 28 mm	ID 26359
2 x B12	590 x 42 x 28 mm	ID 26360
2 x B13	1130 x 42 x 28 mm	ID 26361
2 x B14	1812 x 42 x 28 mm	ID 24123
4 x B15	1922 x 42 x 28 mm	ID 26384
2 x B16	2105 x 42 x 28 mm	ID 24125
4 x B17	2187 x 42 x 28 mm	ID 24534
3 x B18	1874 x 52 x 52 mm	ID 26165

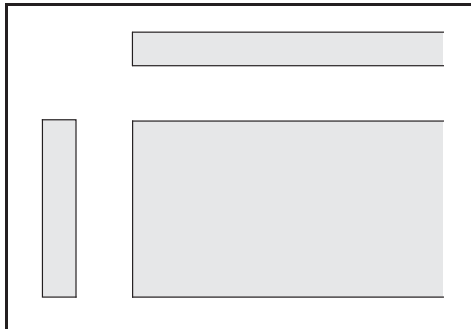

1 x C1	2156 x 95 x 18 mm	ID 28687
--------	-------------------	----------

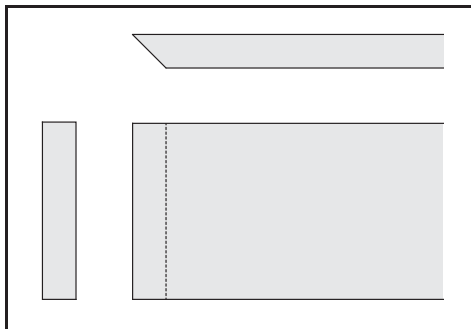

1 x C2	1260 x 95 x 18 mm	ID 14117
1 x C3	1656 x 95 x 18 mm	ID 14116

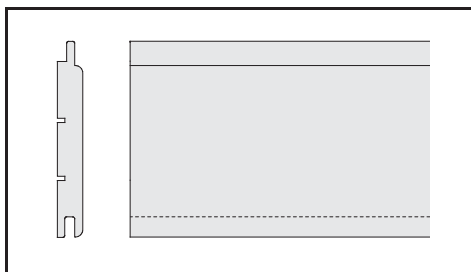

2 x E1	1920 x 97 x 12 mm	ID 22863
--------	-------------------	----------

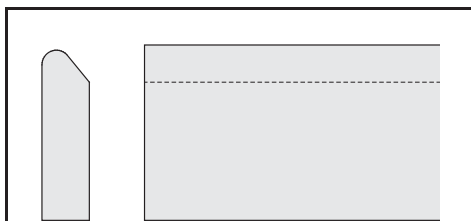

2 x G1	1980 x 95 x 17 mm	ID 48540
--------	-------------------	----------

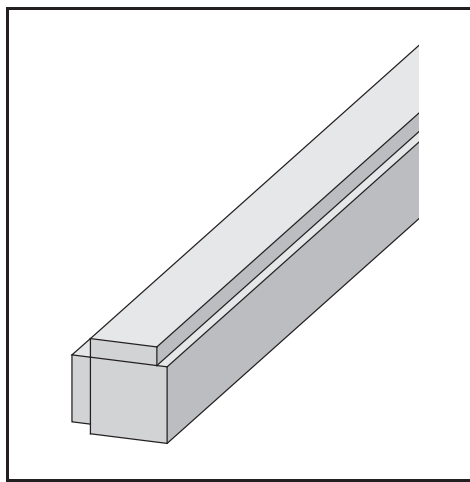

1 x K1	1874 x 64 x 64 mm	ID 24725
--------	-------------------	----------

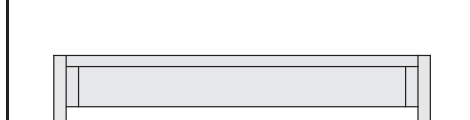
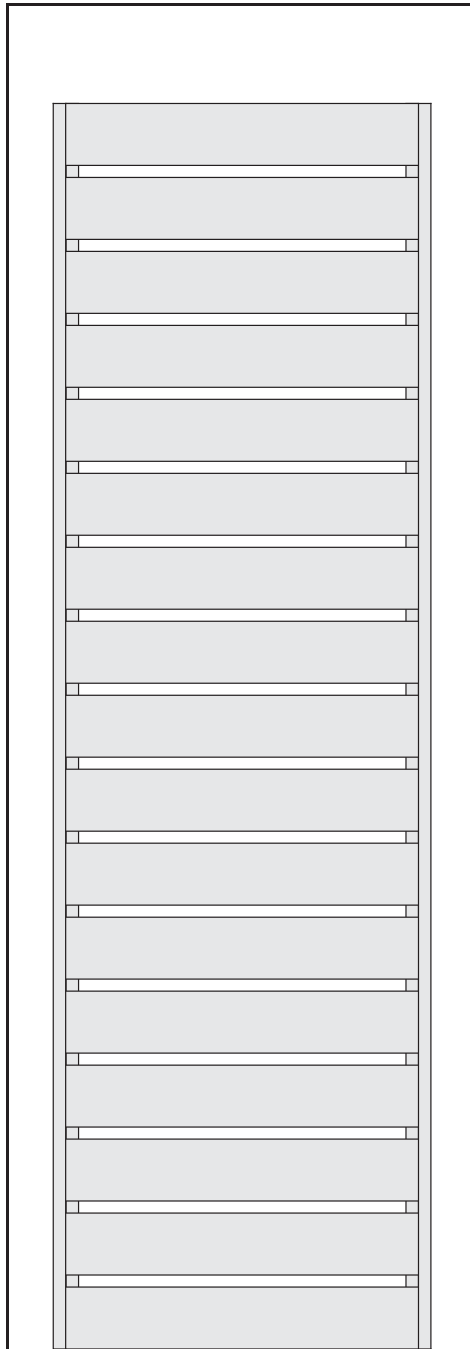

1 x L1	1260 x 500 x 95 mm	ID 61281
2 x L2	2156 x 550 x 95 mm	ID 55193

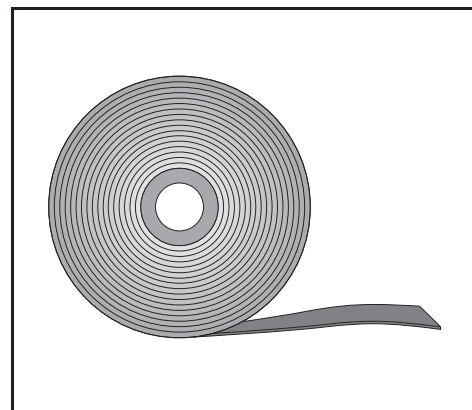

1 x	10 m	ID 14025
-----	------	----------

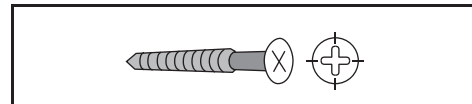

80 x	4 x 30 mm	ID 3686
55 x	4 x 50 mm	ID 3688
50 x	4 x 70 mm	ID 3689
50 x	4,5 x 80 mm	ID 9204
25 x	6 x 60 mm	ID 14014

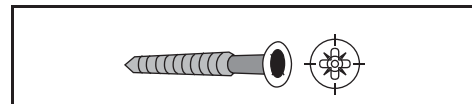

10 x	4,5 x 30 mm	ID 26115
100 x	4,5 x 40 mm	ID 26285

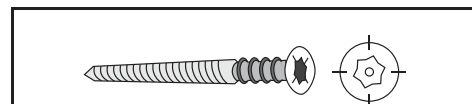

6 x	6 x 80 mm	ID 14266
-----	-----------	----------

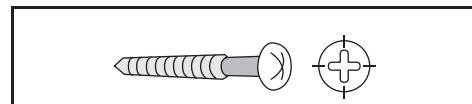

6 x	3 x 16 mm	ID 46376
-----	-----------	----------

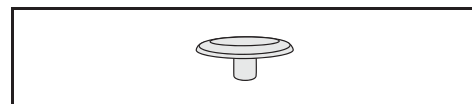

150 x	4,5 x 30 mm	ID 26116
16 x	12 x 18 mm	ID 46403

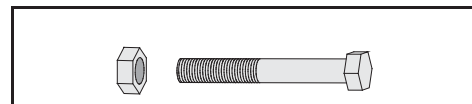

3 x	8 x 70 mm	ID 42172
-----	-----------	----------

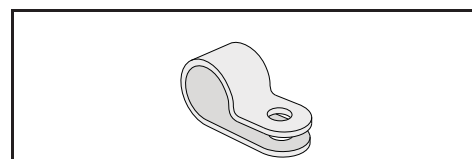

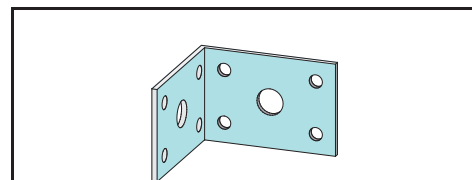

1 x		ID 50420
-----	--	----------



2 x		ID 21292
-----	--	----------

 Übersicht
 Overview
 enquête

 overzicht
 undersøgelse
 estudio

 sondaggio
 přehled

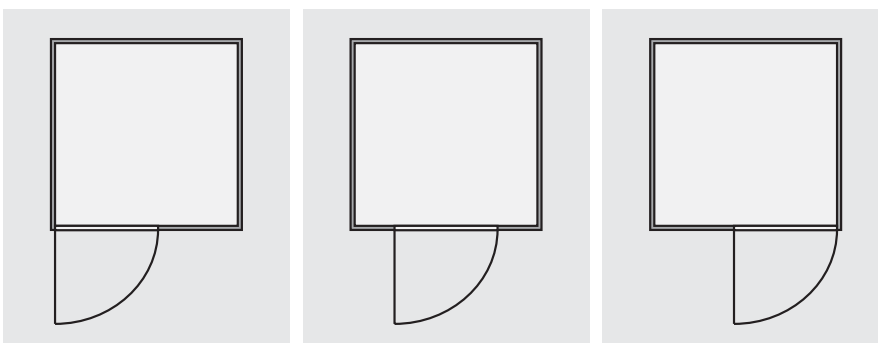
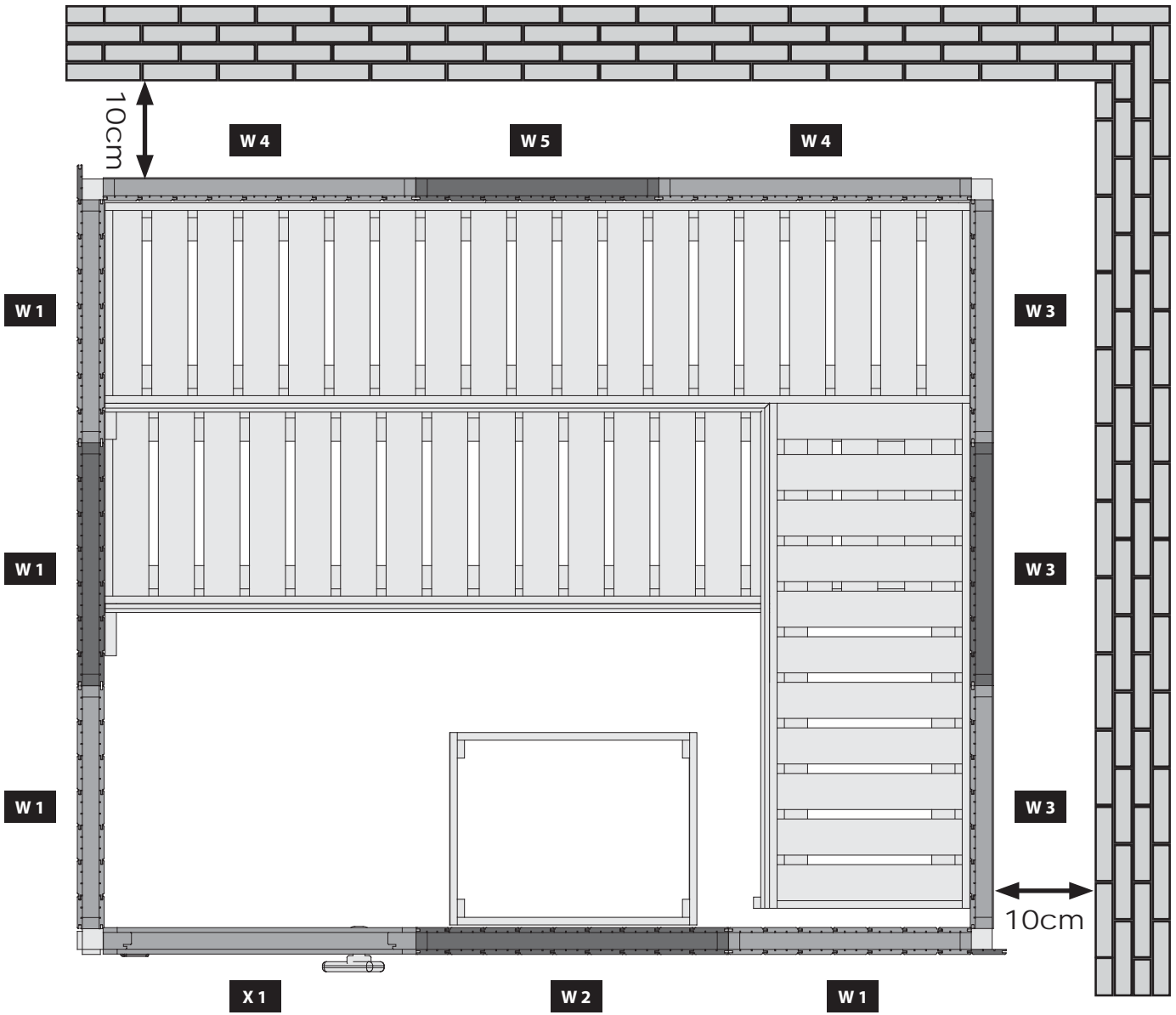

 Einbau Tür
 Installation door
 Porte d'installation
 Installatie deur
 Installationsdør
 Puerta de instalación
 Porta di installazione
 Montážní dveře

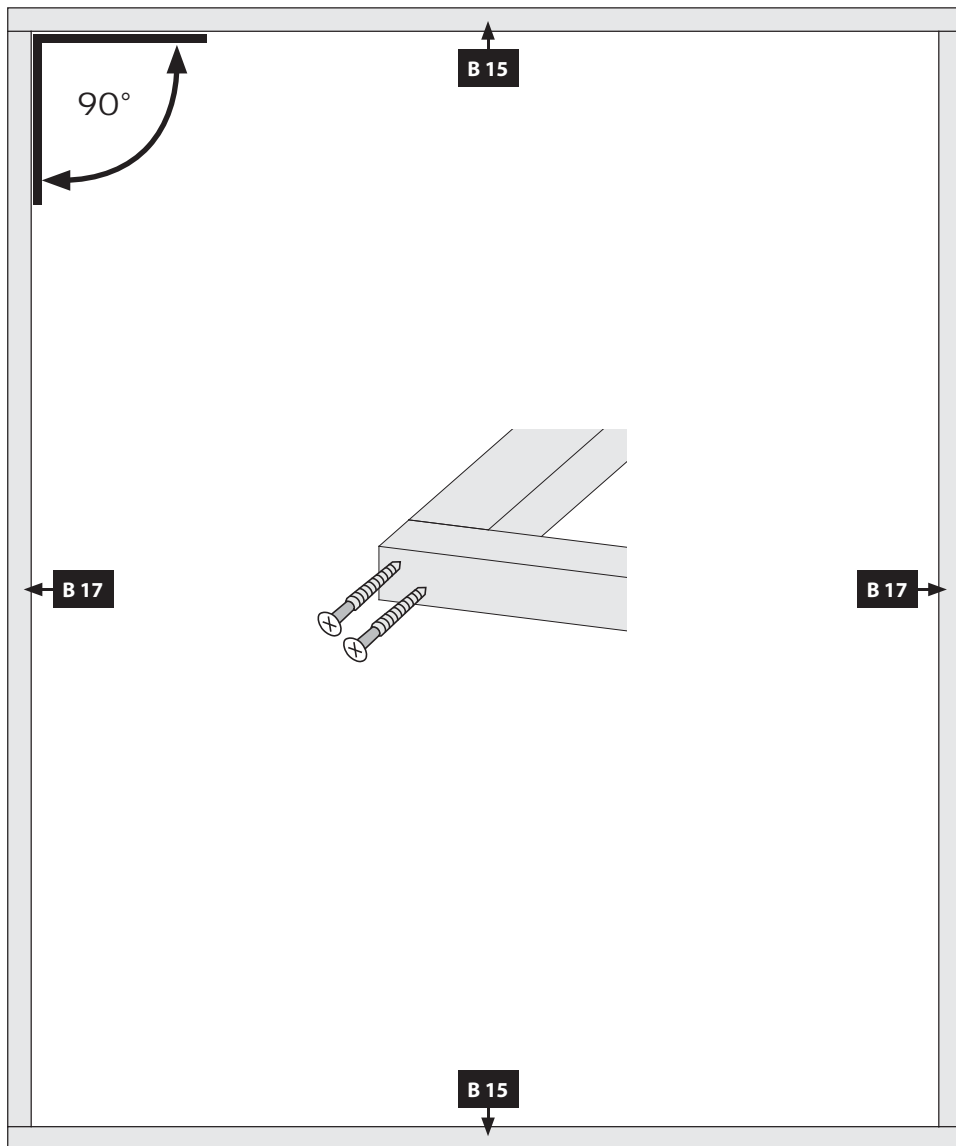
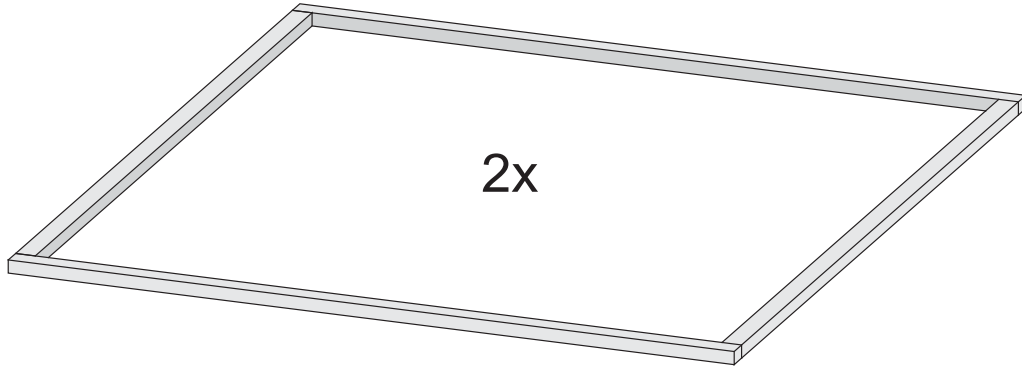
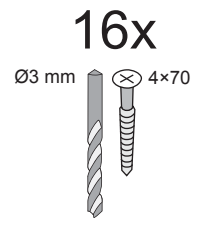
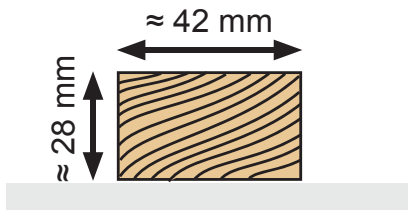

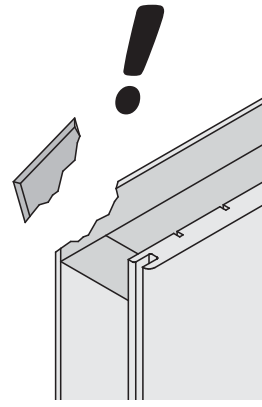
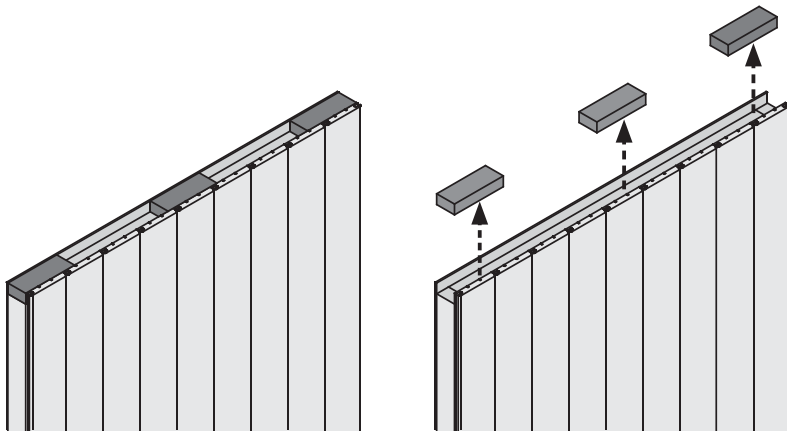

-  Vorsicht!
-  Attention!
-  Attention!
-  Voorzichtig!
-  Forsigtig!
-  Cuidado!
-  Occhio!
-  Pozor!

02

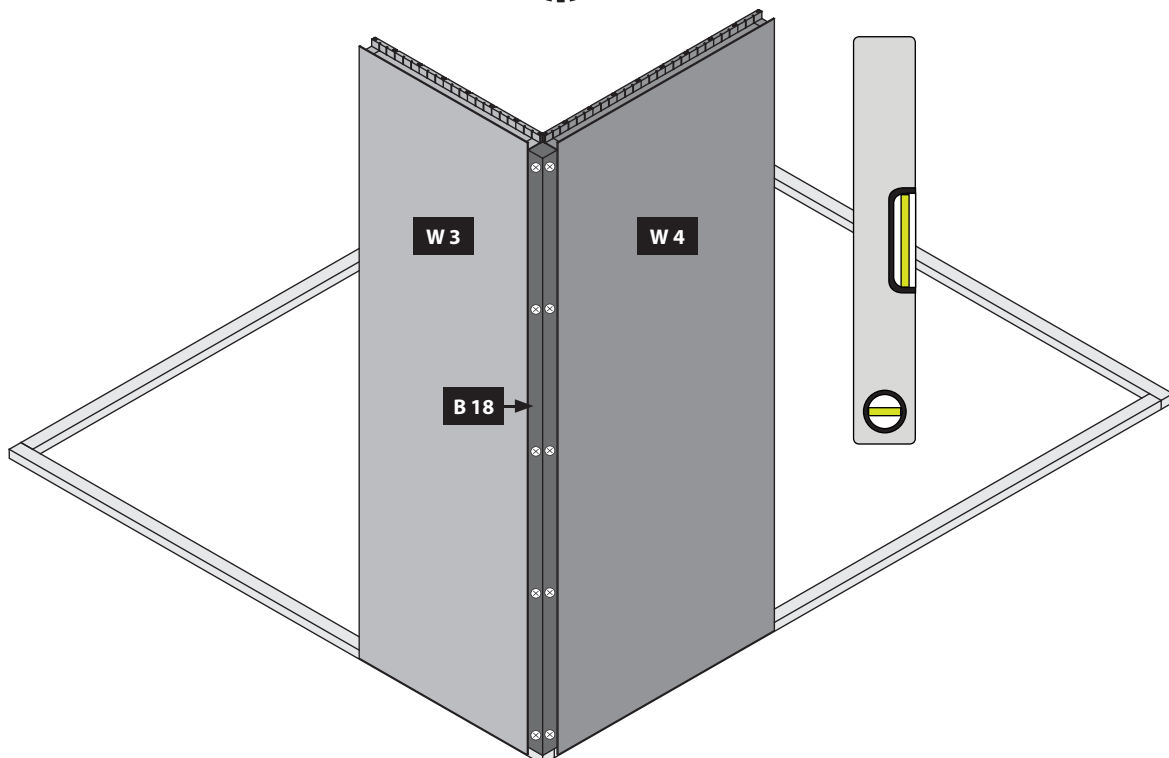
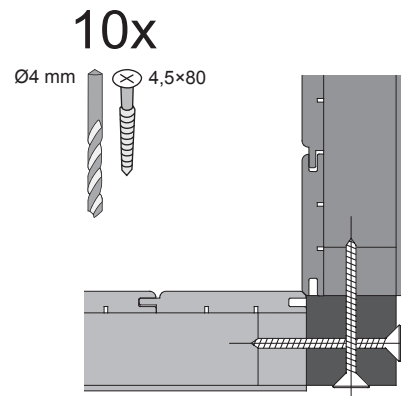
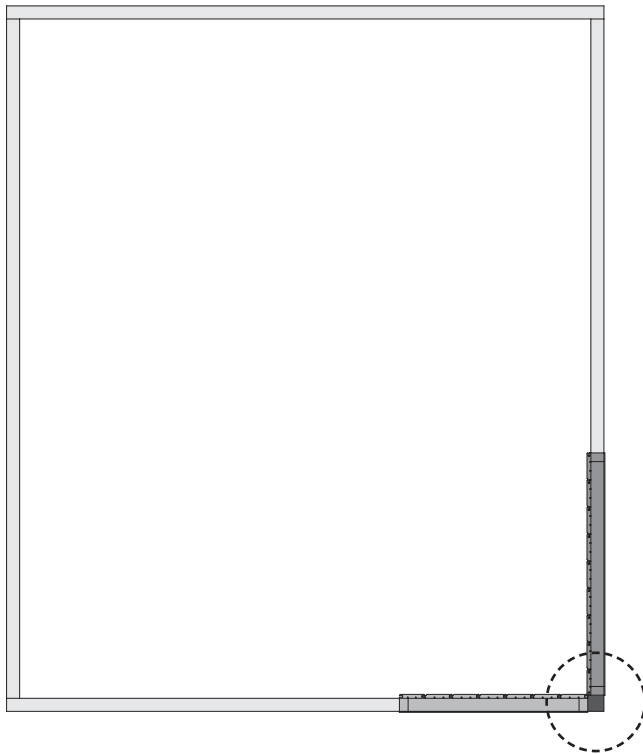

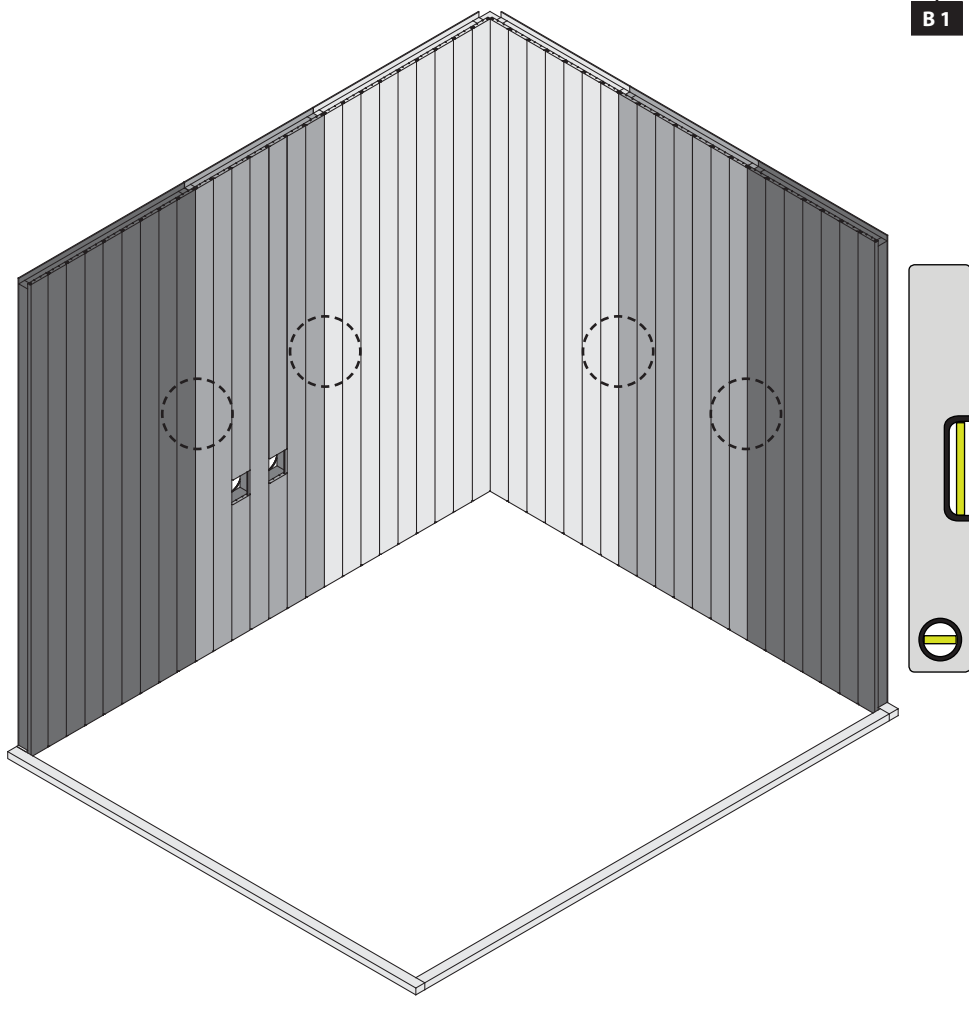
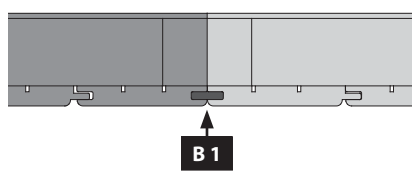
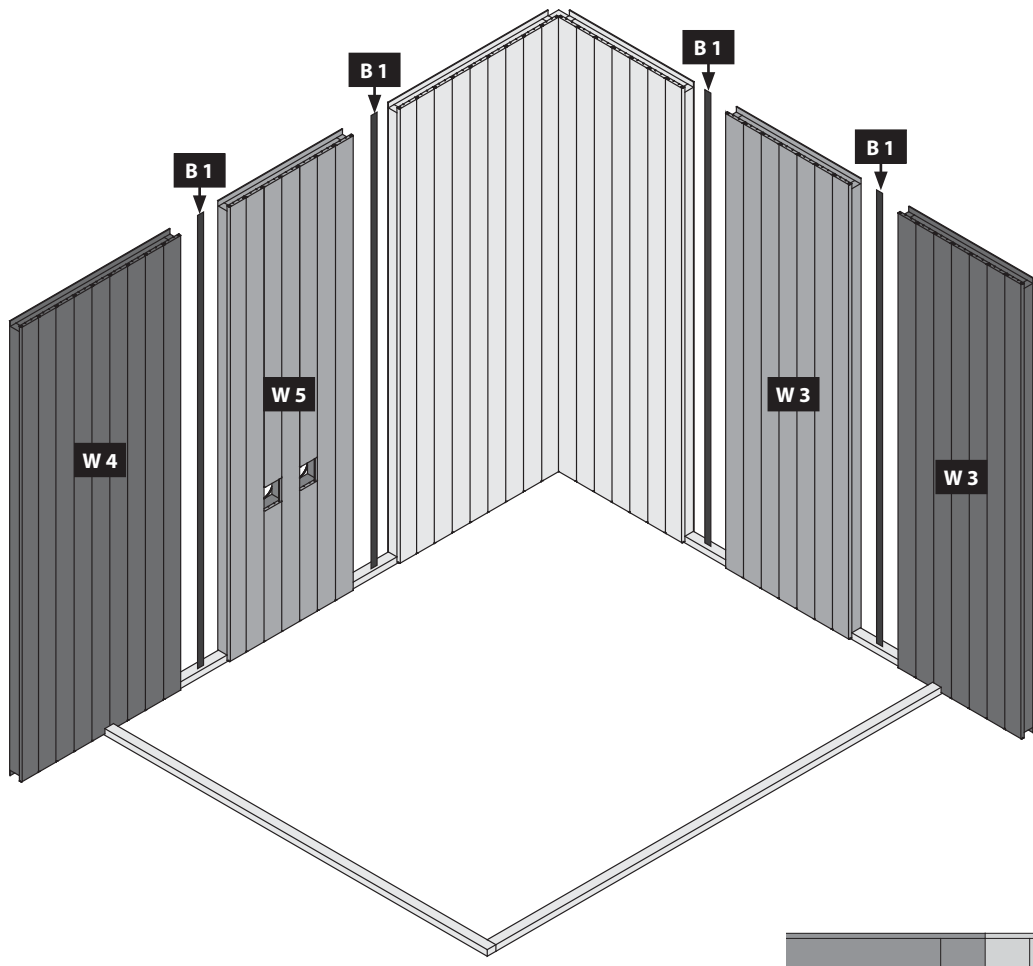

04



10x

Ø4 mm

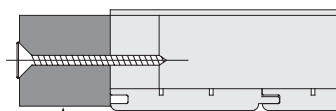
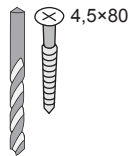

B 18

B 18

B 18

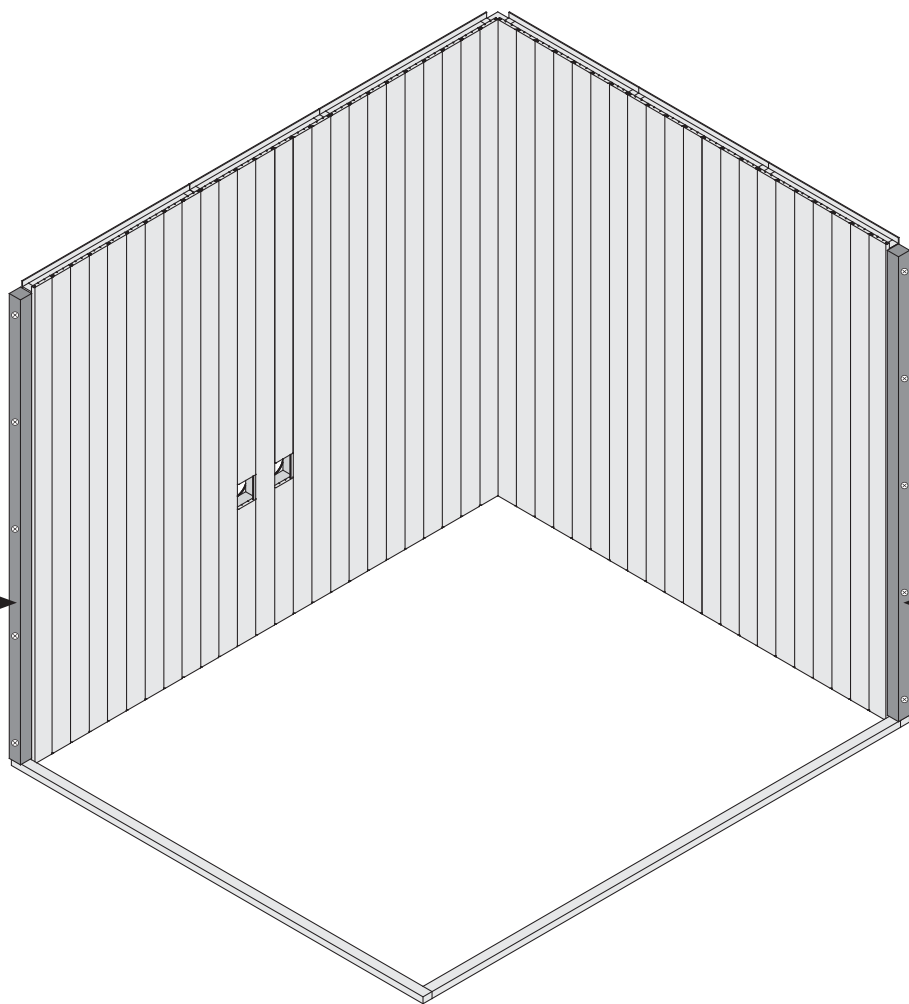

05



10x

Ø4 mm

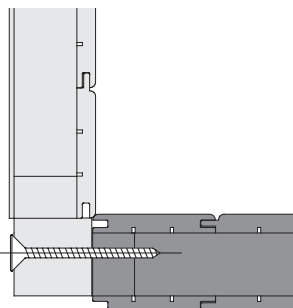
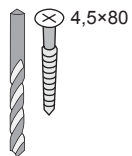





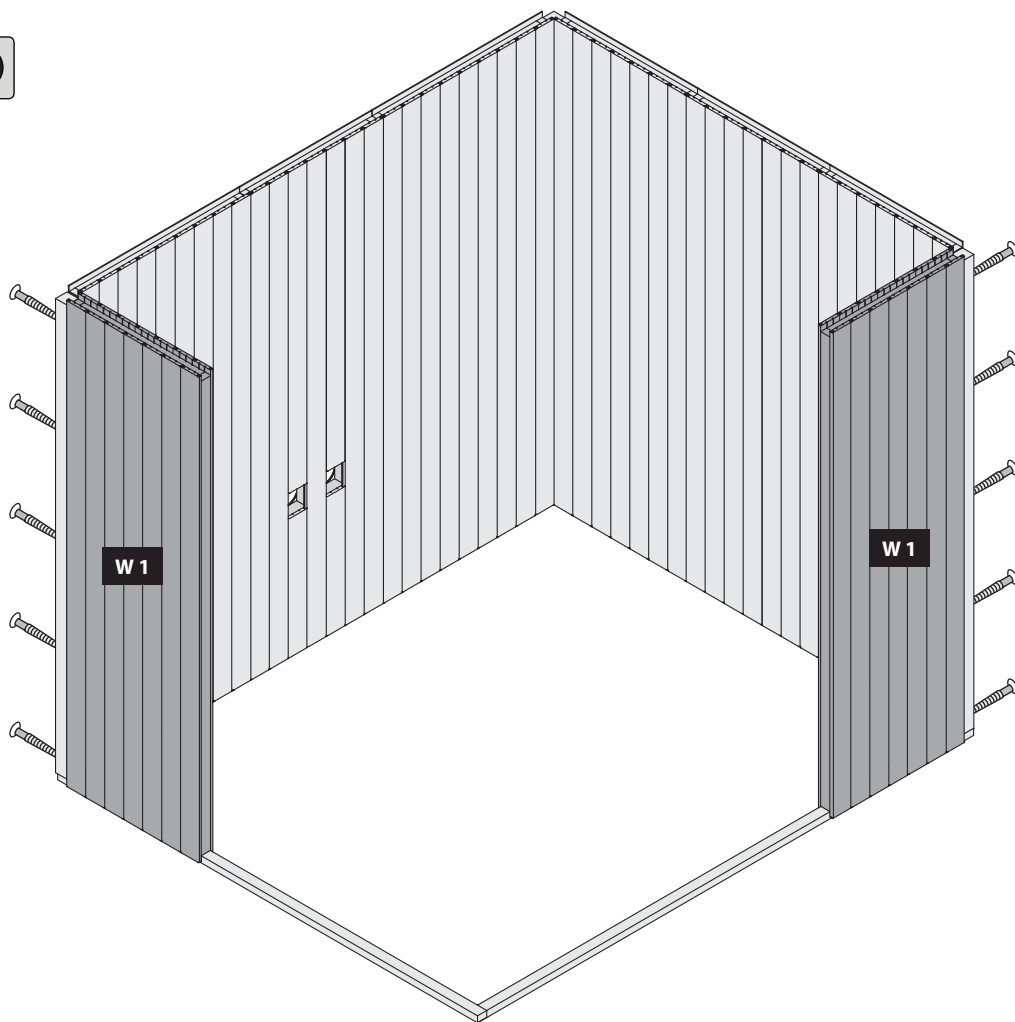

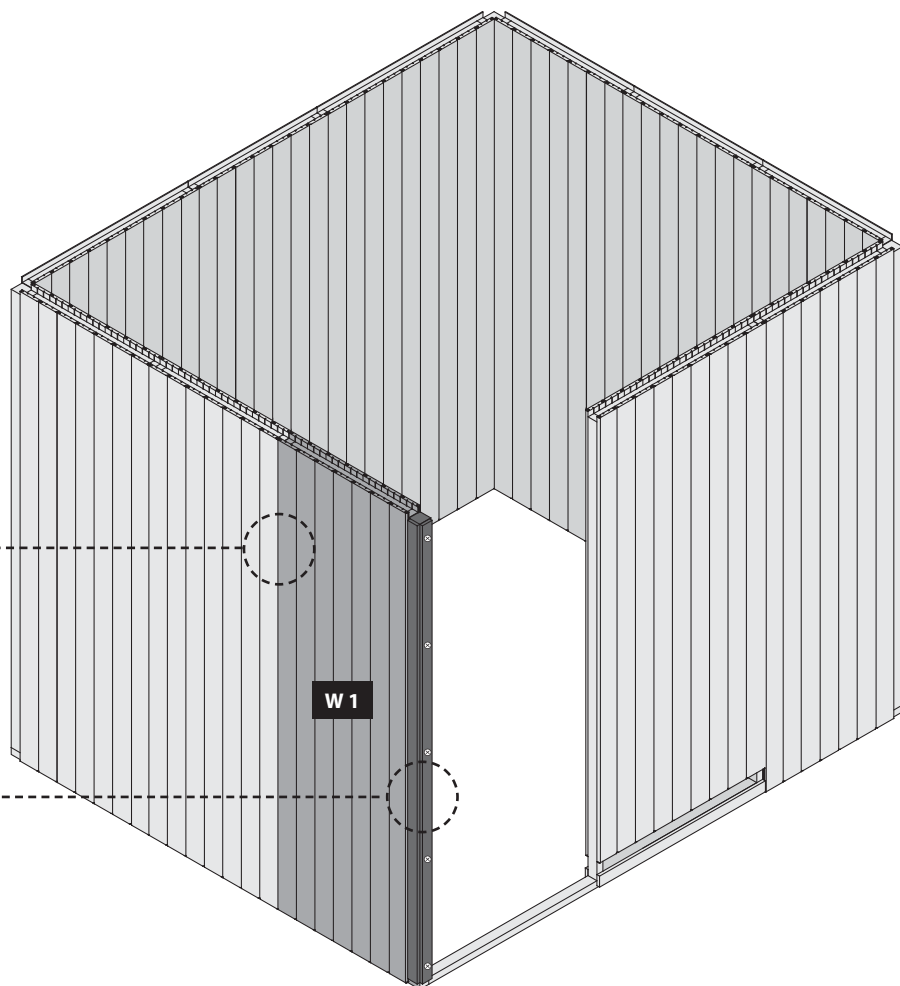
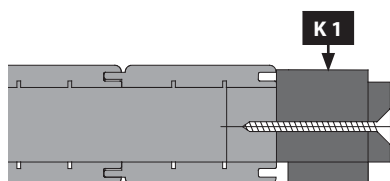
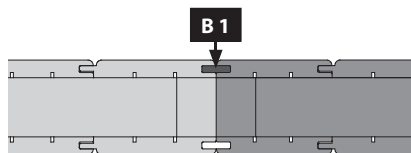
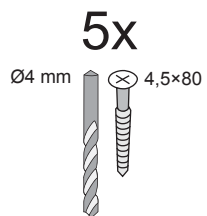
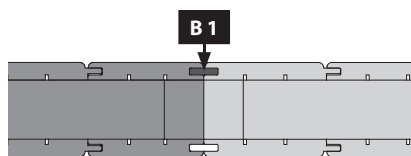
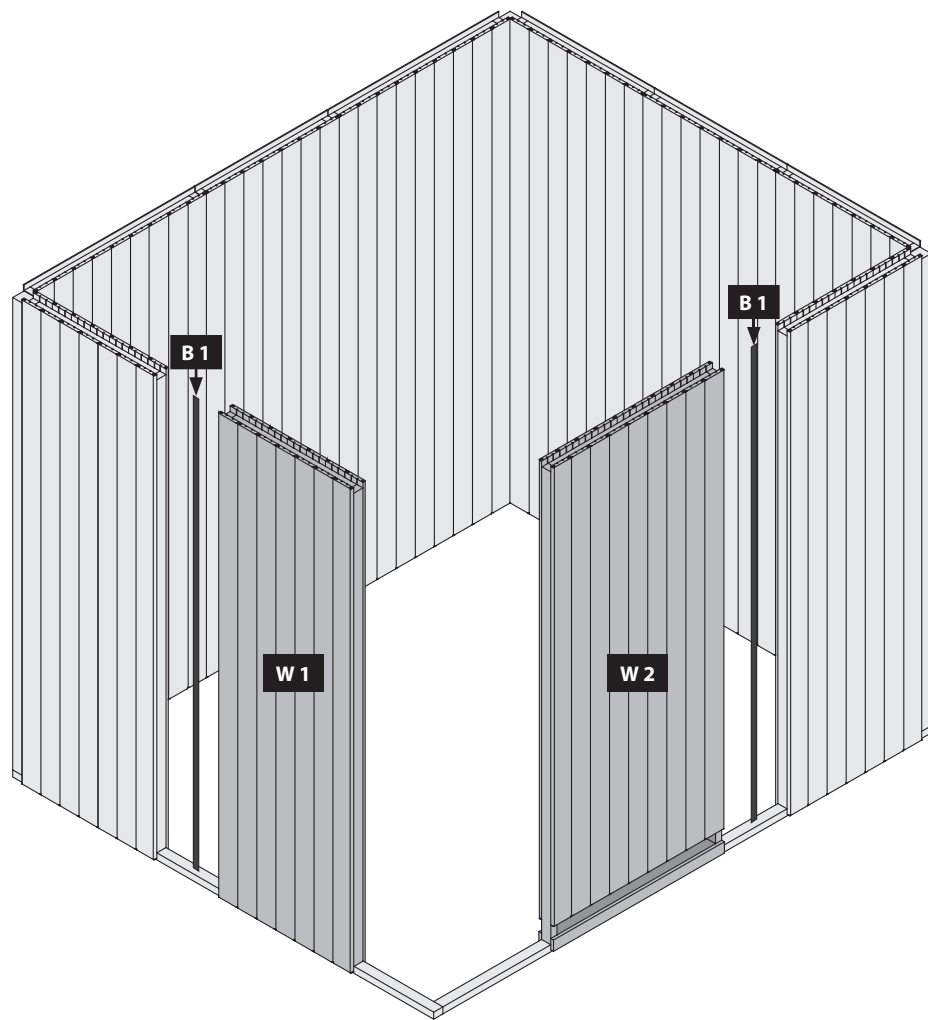

W 1

W 1





-  Einbau Glastür
-  Installation of glass door
-  Montage porte en verre
-  Montage van de glazen deur

-  Installationsglasdør
-  Montaje de la puerta de cristal
-  Installazione portello di vetro
-  Sauna Instalace dveře

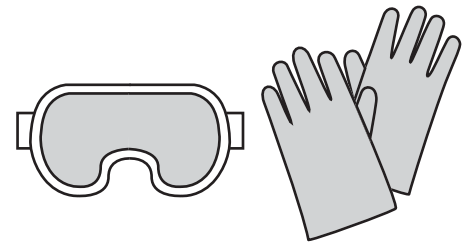

08

-  Saunätürglas in den Türrahmen legen
-  Put the door glass in the frame
-  Mettez le verre de la porte dans le cadre
-  Plaats het deurglas in het frame
-  Sæt dørglasset i rammen
-  Pon el vidrio de la puerta en el marco
-  Metti il vetro della porta nel telaio
-  Vložte sklo dveří do rámu

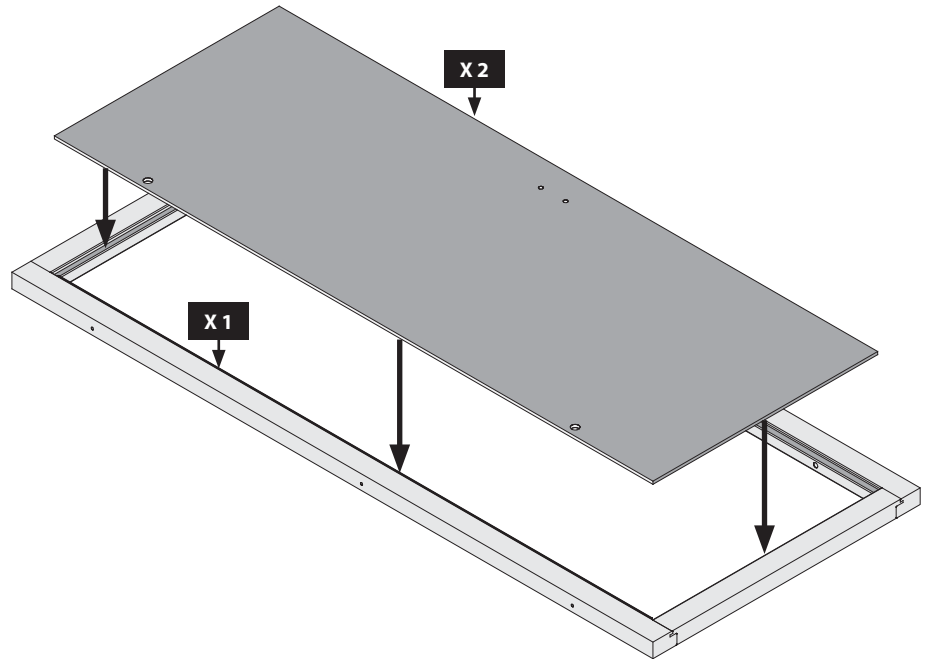

-  Saunätürglas in den Türrahmen ausrichten
-  Center the glass in the wooden frame
-  Bien aligner le verre à vitre
-  Lijn het glas uit in het deurframe
-  Juster saunaens dørglas i dørkarmen
-  Alinee el vidrio en el marco de la puerta
-  Allineare il vetro nel telaio della porta
-  Skleněná dvířka sauna v zárubně zarovnat

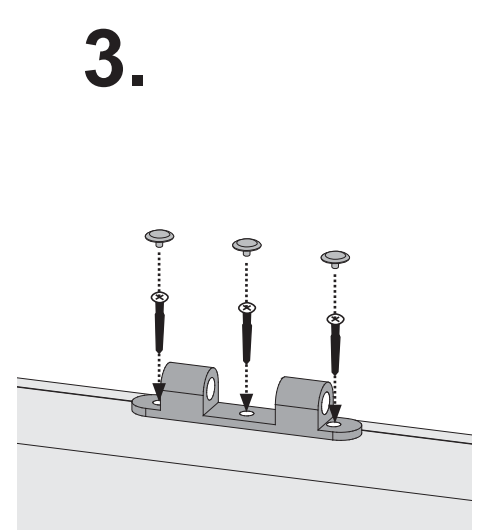
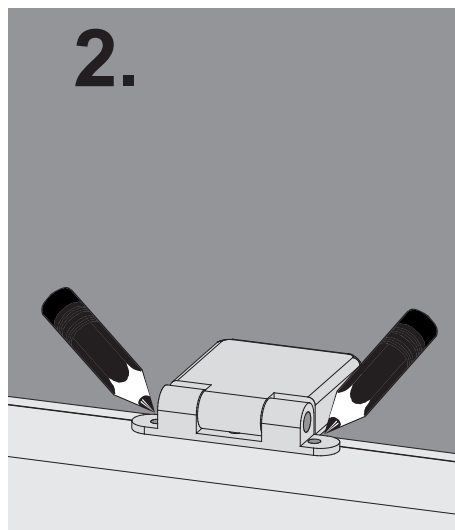
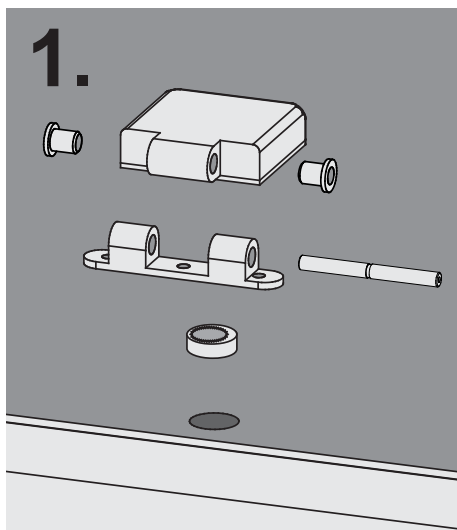
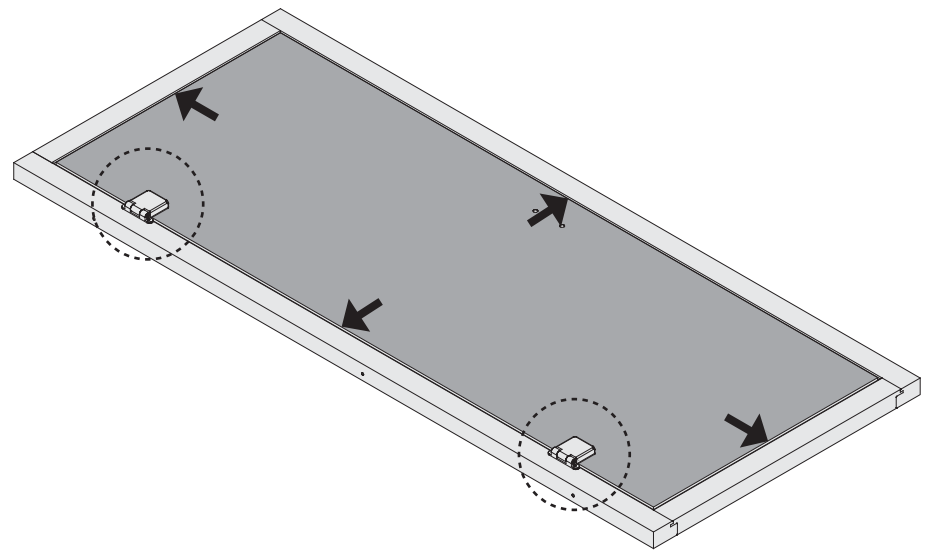

6x

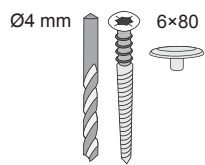

X 1

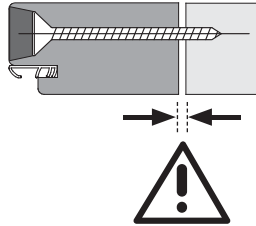
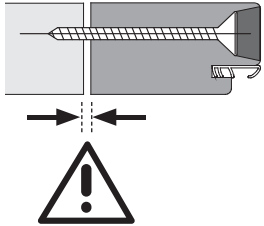
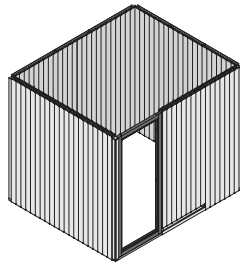
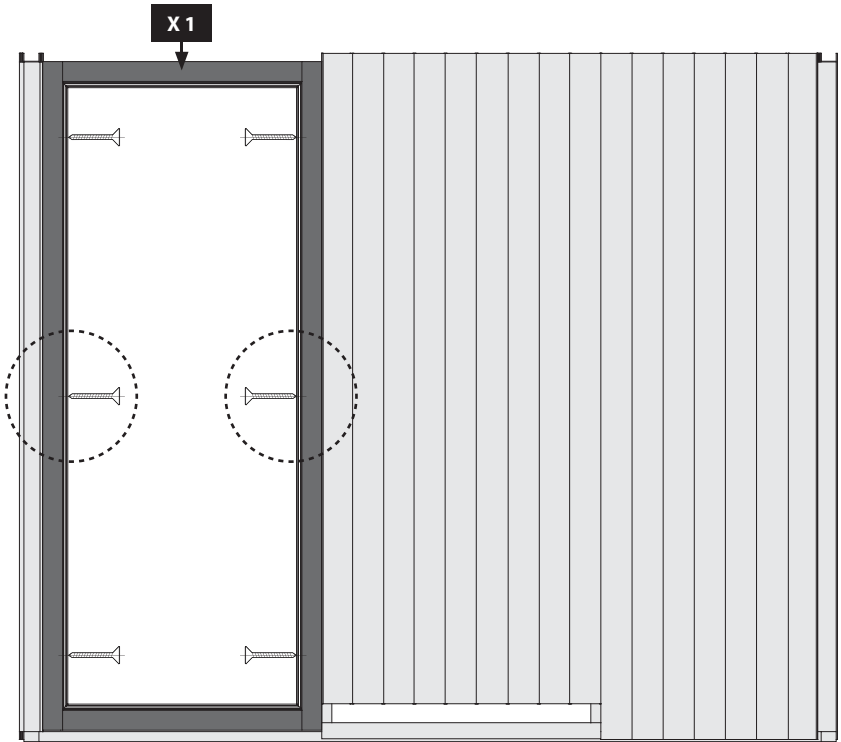

01 !

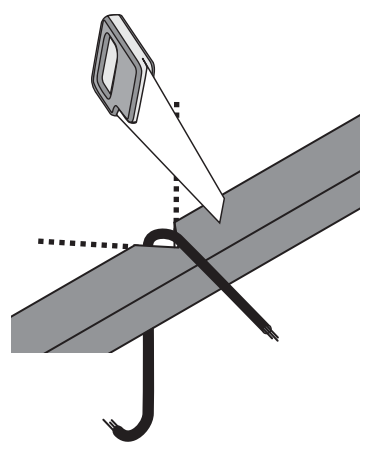
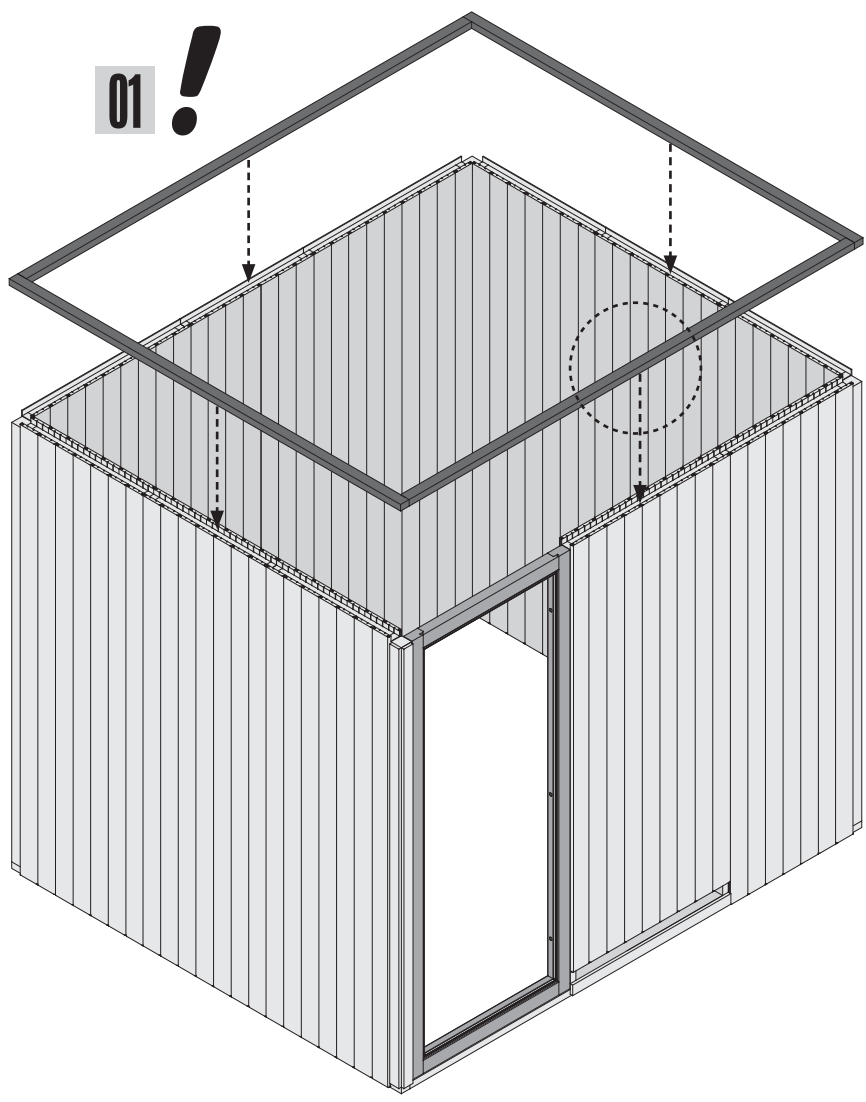

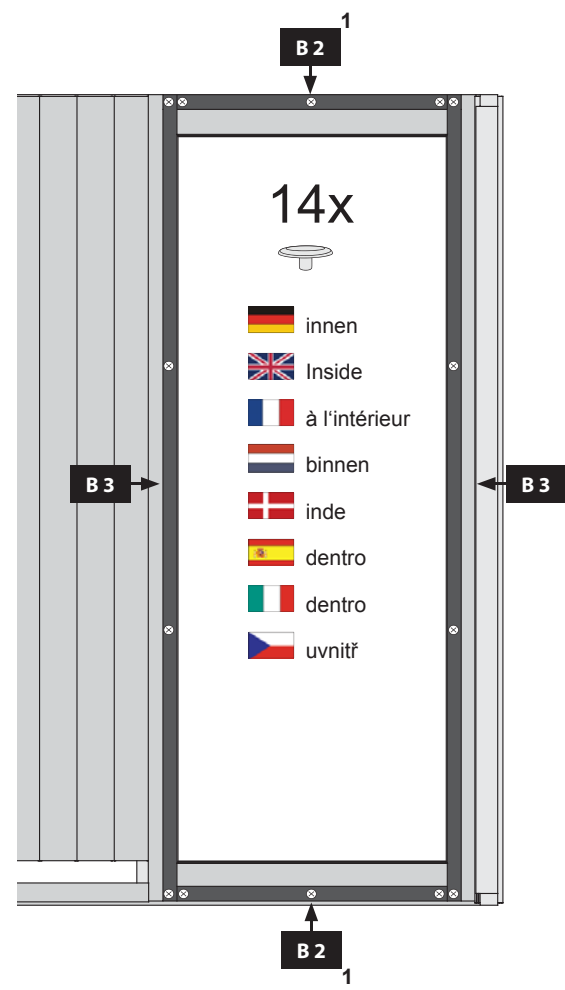
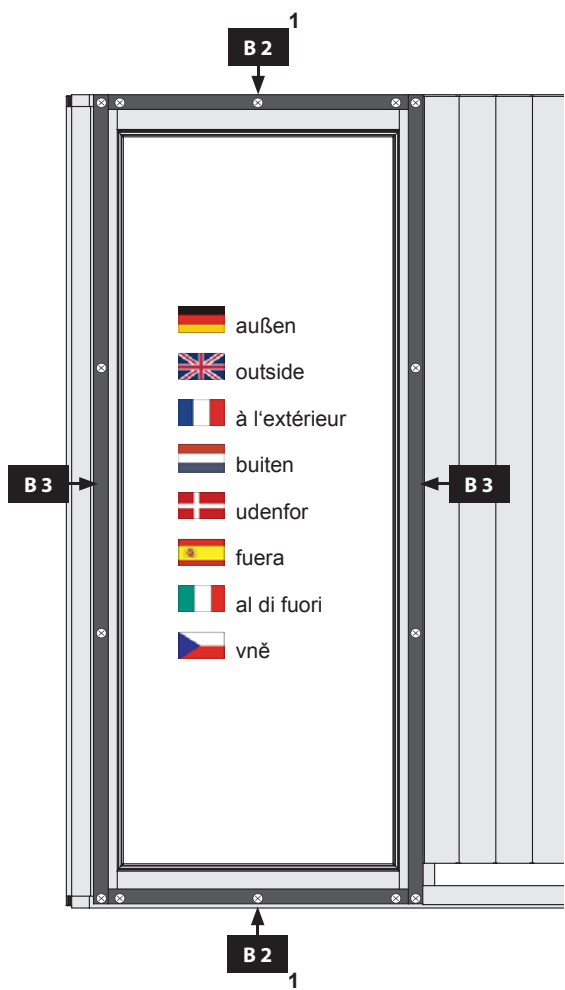
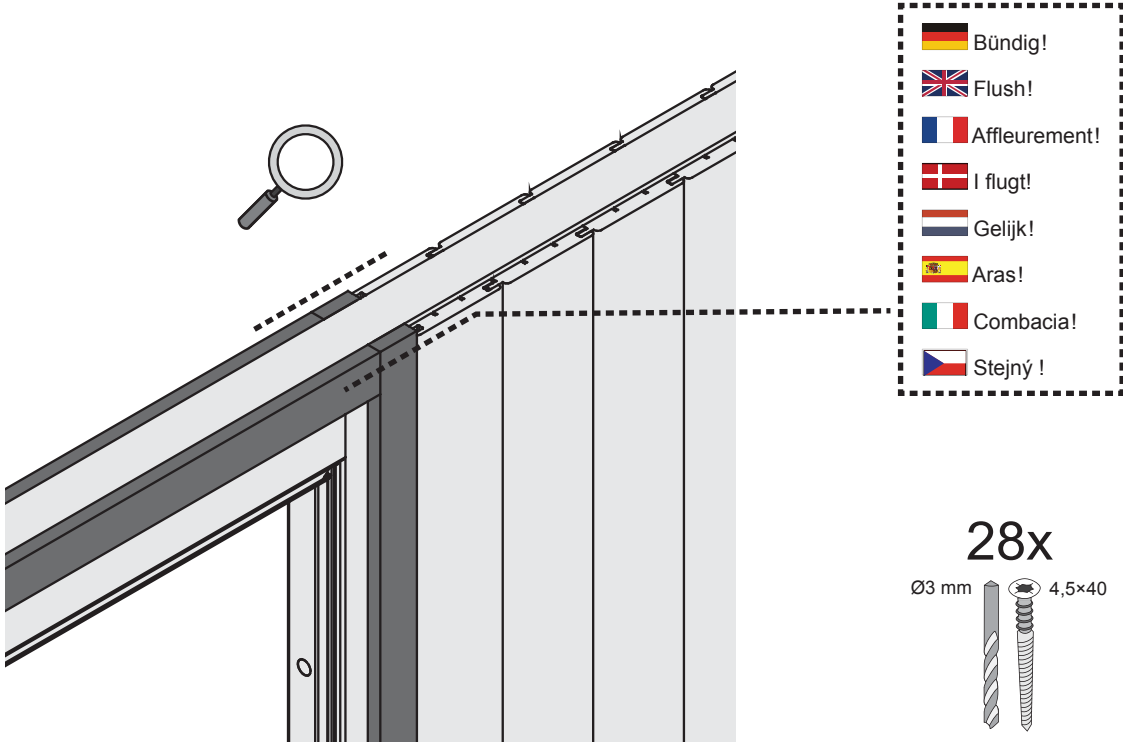

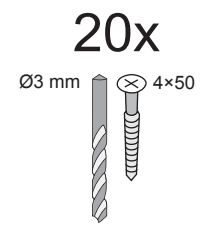
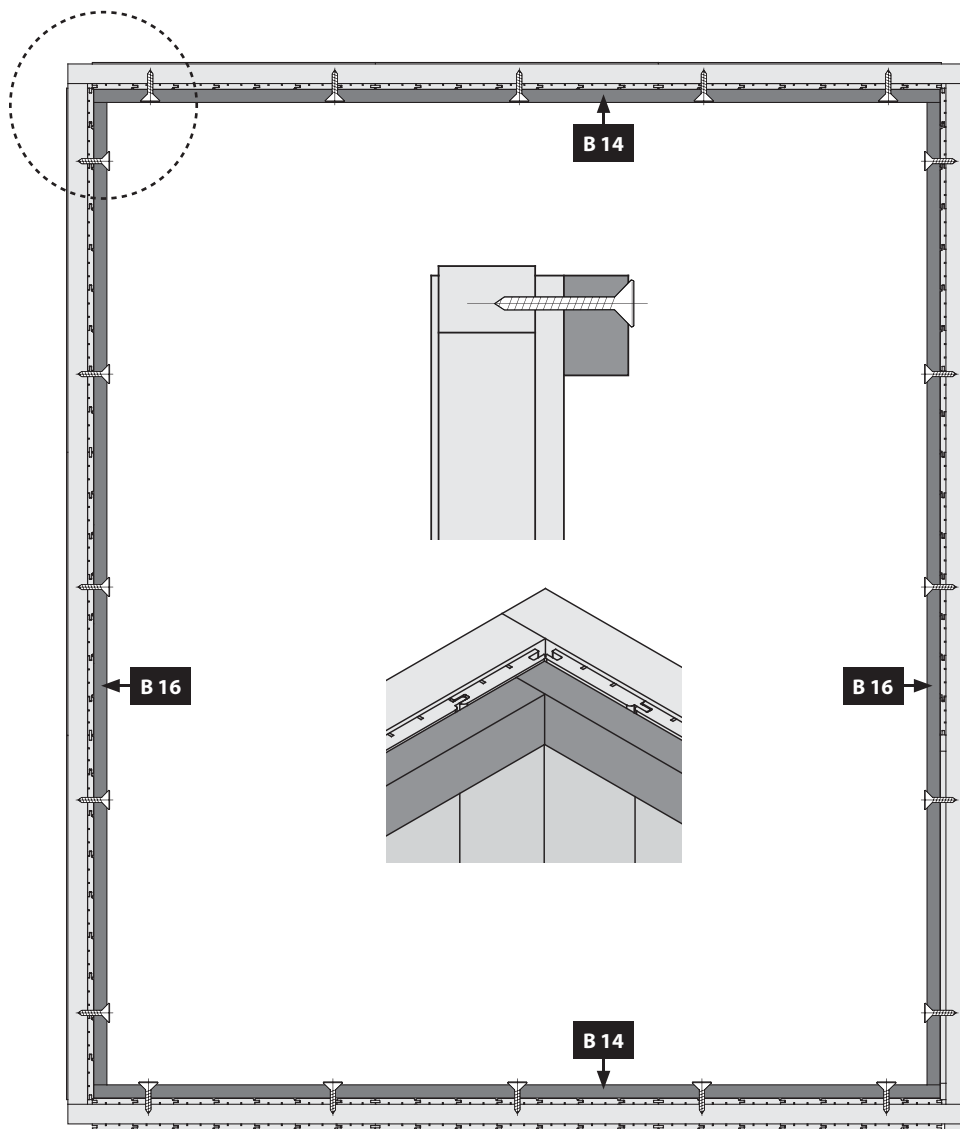

-  Draufsicht
-  Top view
-  vue de dessus
-  bovenaanzicht
-  vista desde arriba
-  vista desde arriba
-  vista dall'alto
-  půdorys

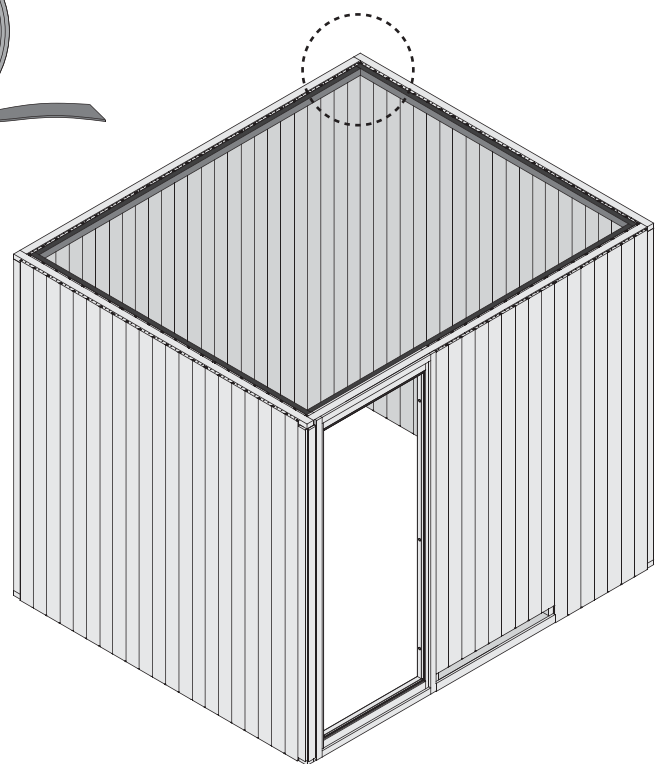
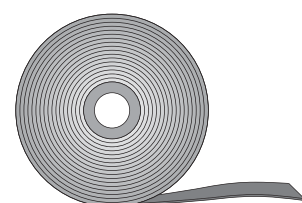
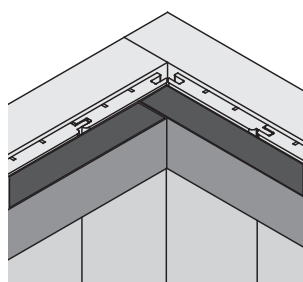

-  Sauna Dichtband
-  Sauna sealing tape
-  Ruban d'étanchéité pour sauna
-  Sauna tætningsbånd
-  Sauna afdichtingstape
-  Cinta de sellado de sauna
-  Nastro sigillante per sauna
-  Sauna těsnící páska

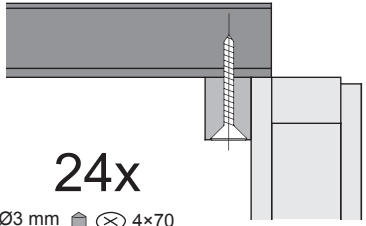
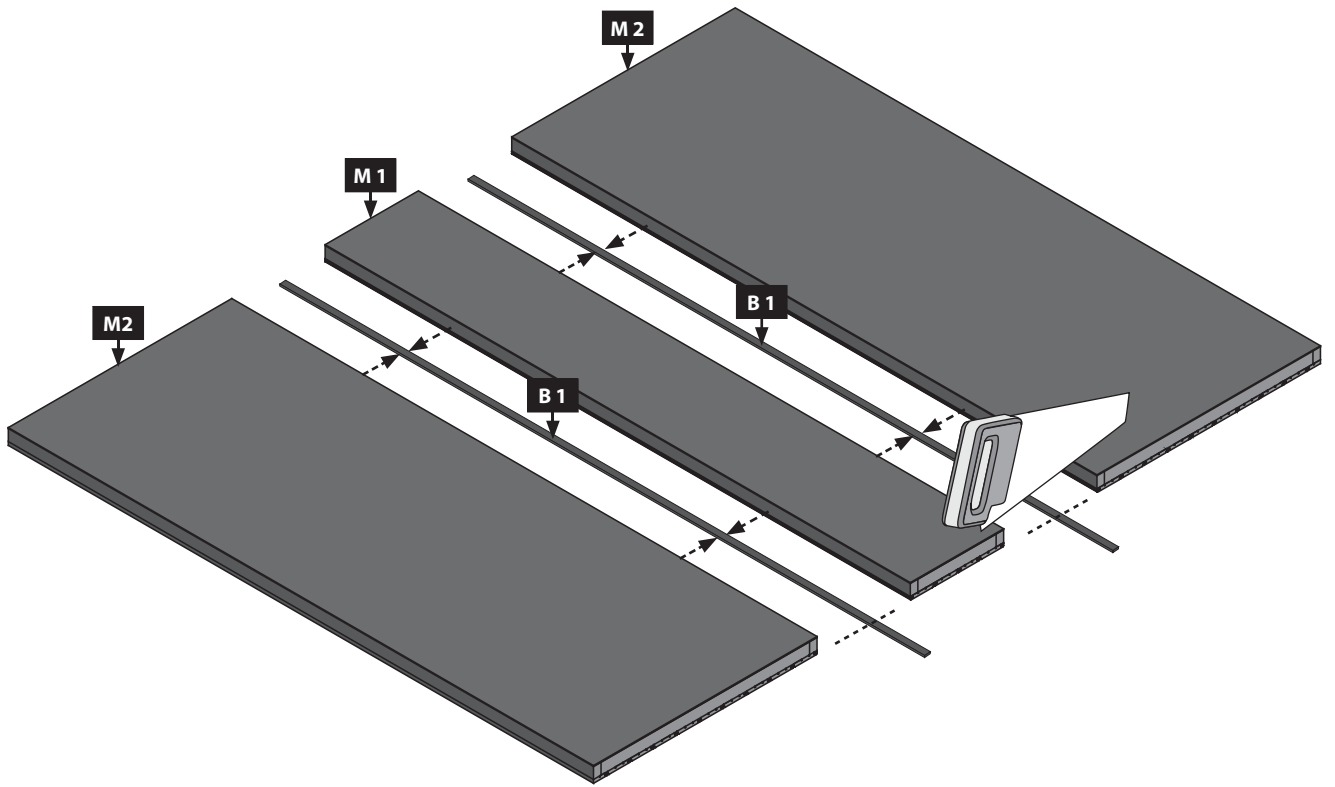

24x
Ø3 mm 4x70

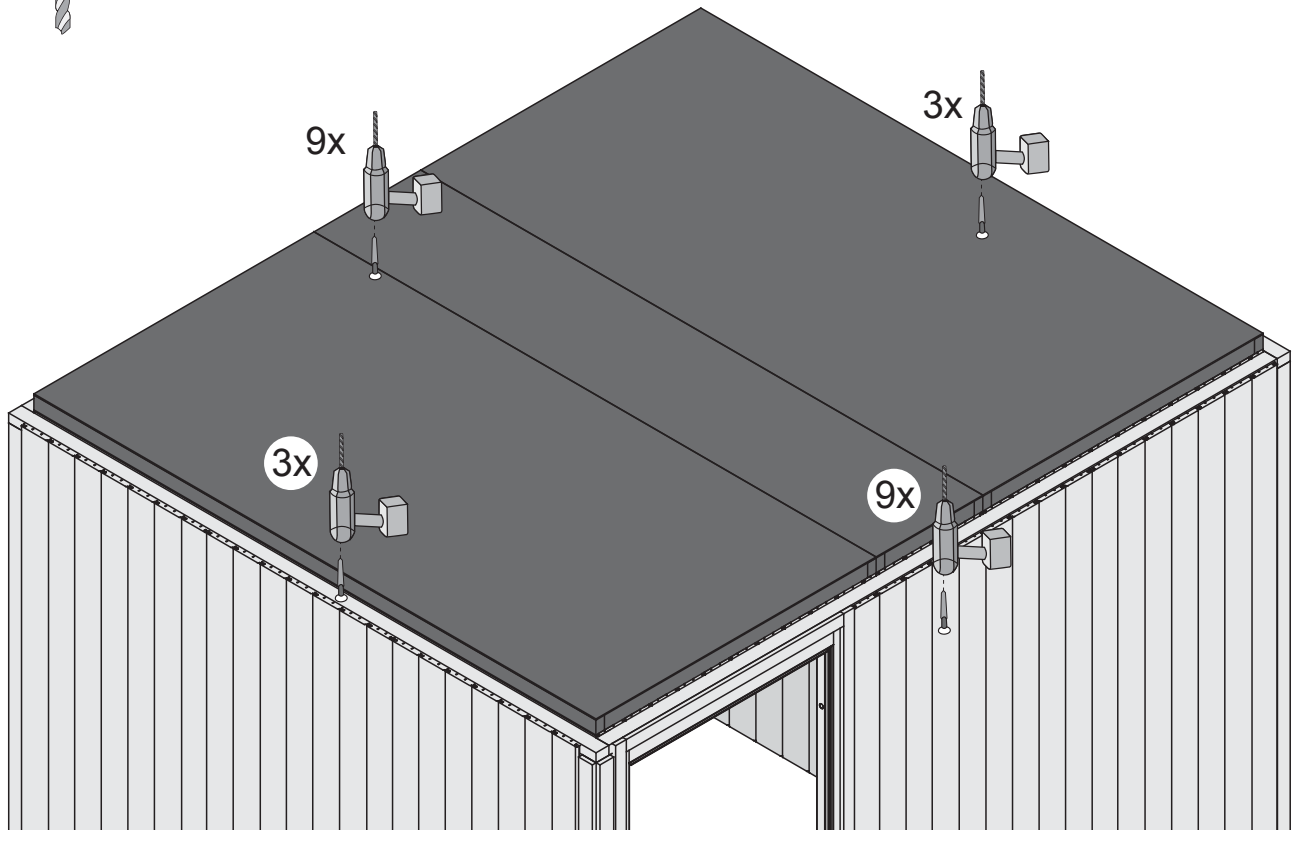

8x
Ø4 mm 4,5x40

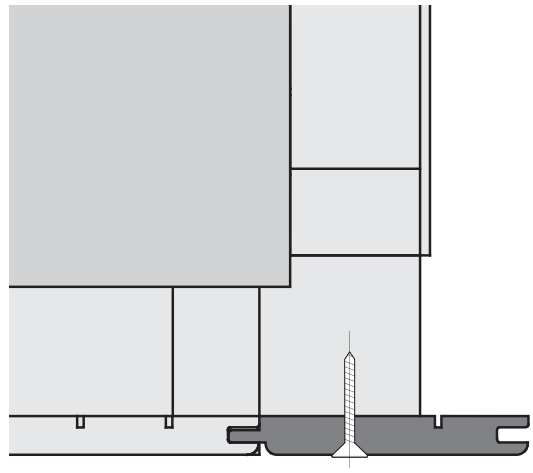
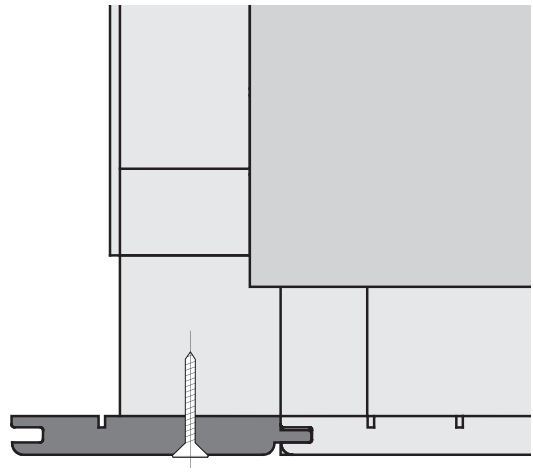
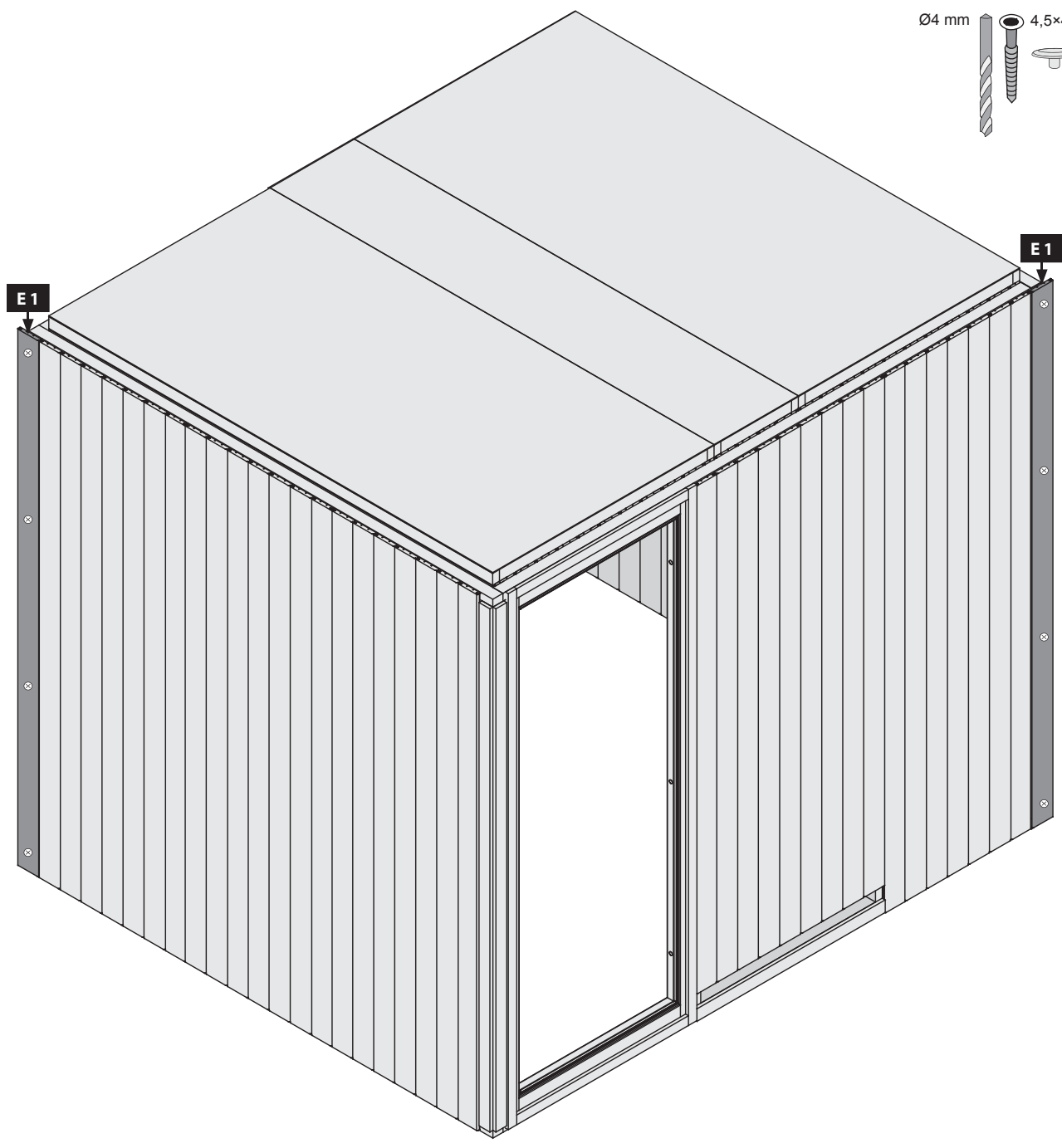
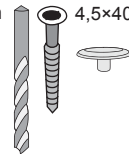

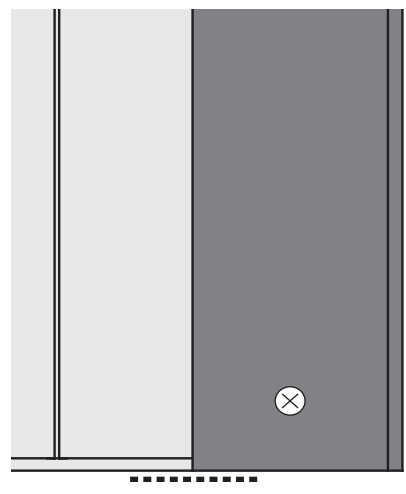
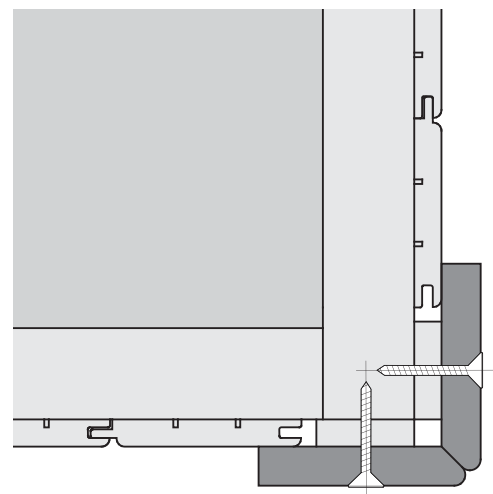
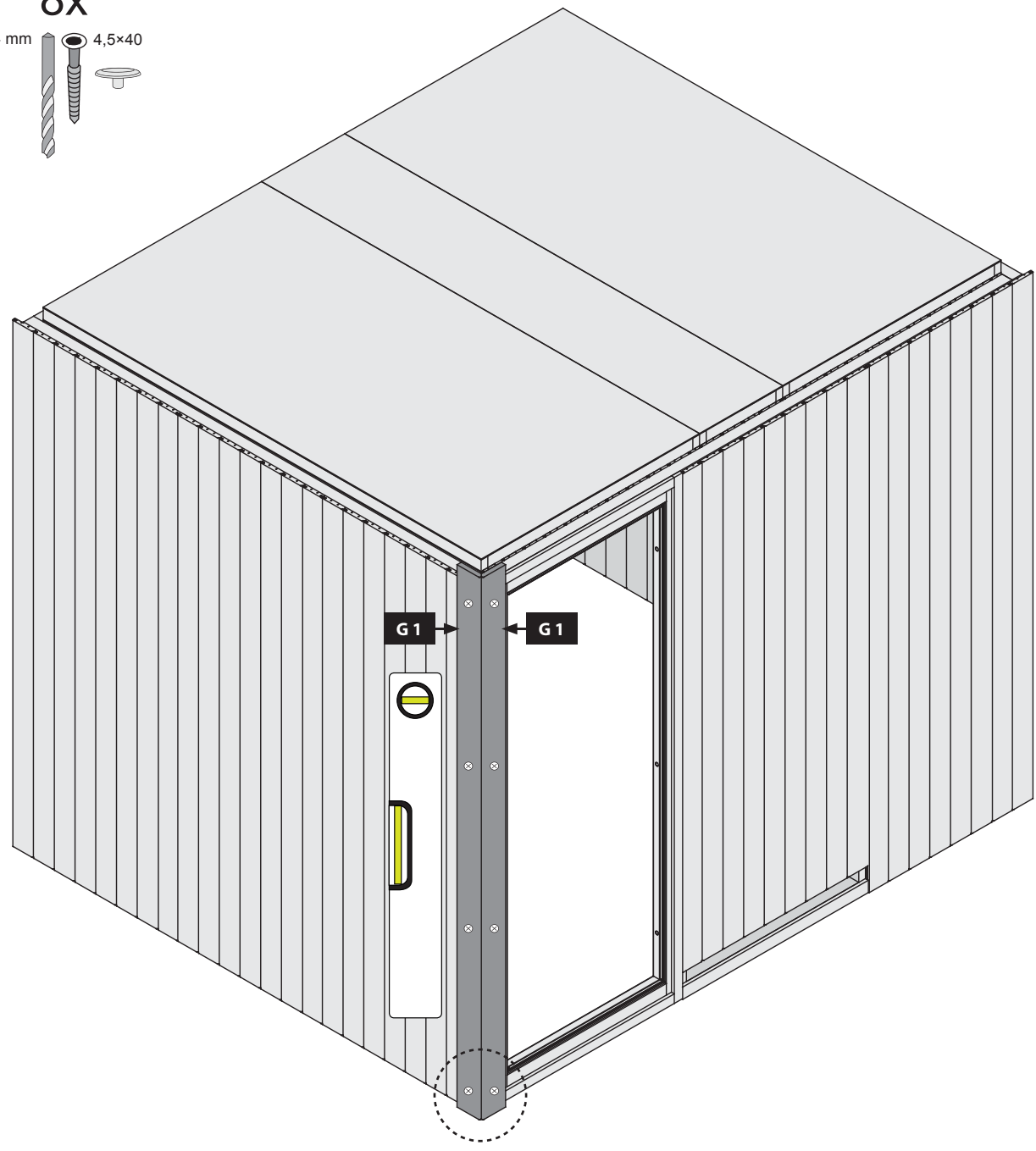

8x
 Ø4 mm 4,5x40



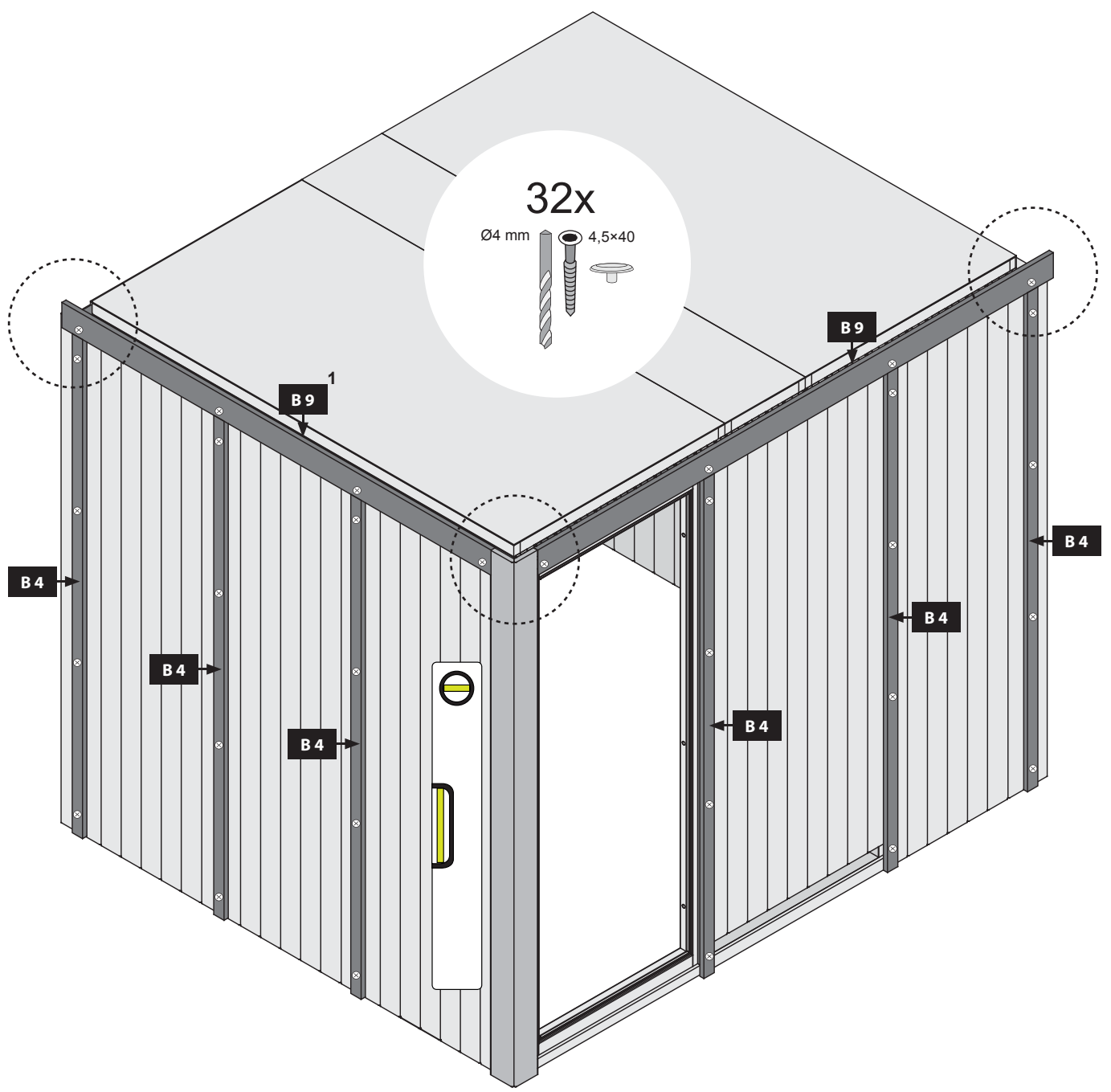
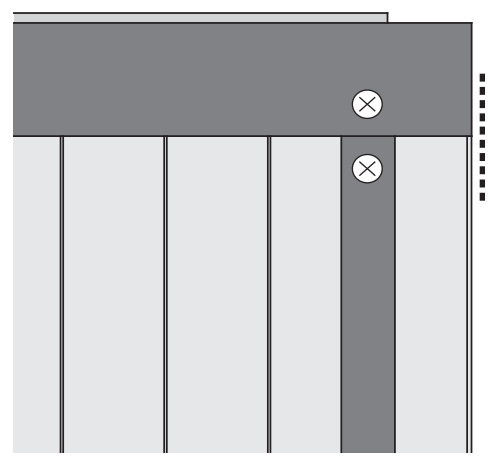
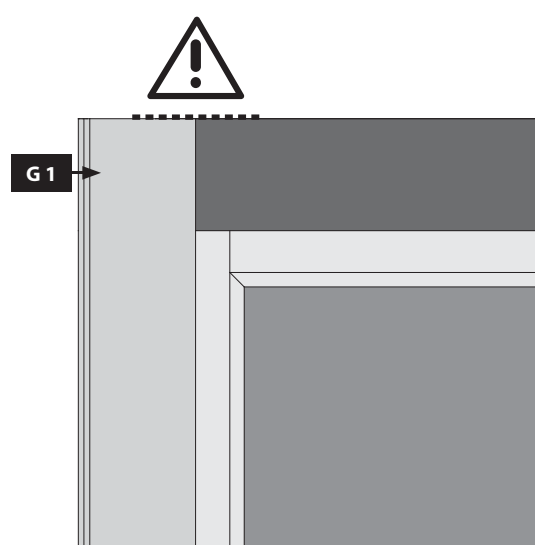

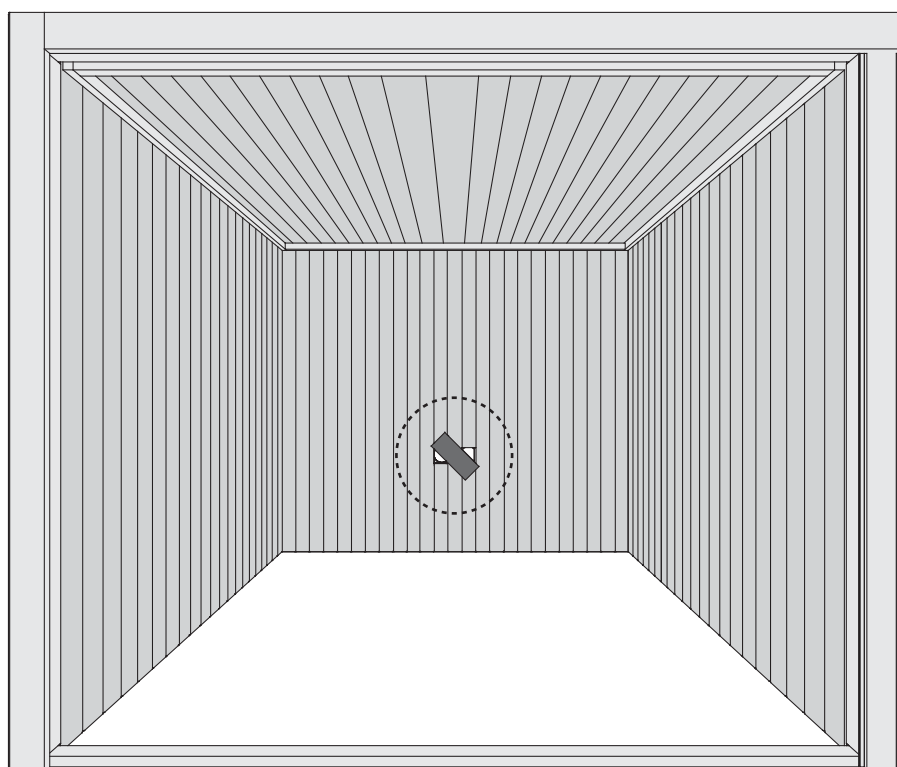
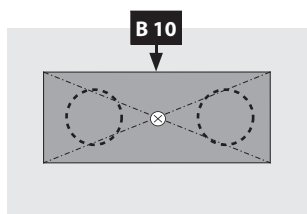
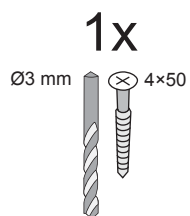
-  Bündig!
-  Flush!
-  Affleurement!
-  I flugt!
-  Gelijk!
-  Aras!
-  Combacia!
-  Stejný !







 Hier ist die Funktionsweise des Brettes abgebildet. Regeln Sie damit die Abluft nach Ihren eigenen Wünschen

 This figure shows the functional principle of the board. Regulate the exhaust air according to your own wishes

 Ceci représente le mode de fonctionnement de la planche. Avec elle, réglez l'écoulement de l'air selon vos désirs.

 Hier is de werking van het plankje afgebeeld. Regel daarmee de luchtafvoer naar eigen wens

 Sådan fungerer styret. Brug den til at regulere udstødningsluften efter dine egne ønsker

 Aquí está representada la forma de funcionamiento de la tabla. Regule con ello el aire de salida según sus propios deseos

 Viene illustrato il principio di funzionamento della tavoletta di regolazione della ventilazione. Con essa si può regolare a piacere la ventilazione

 Zde je zobrazená funkce desky. Regulujte s ní odsávací vzduch dle Vašeho přání

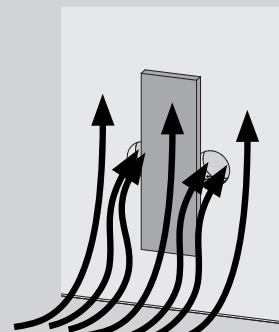
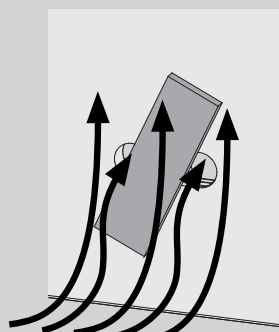
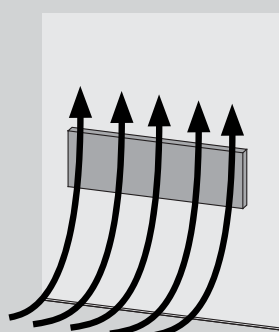

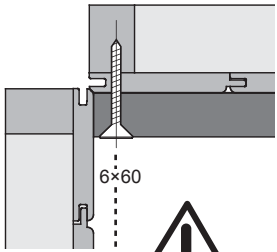
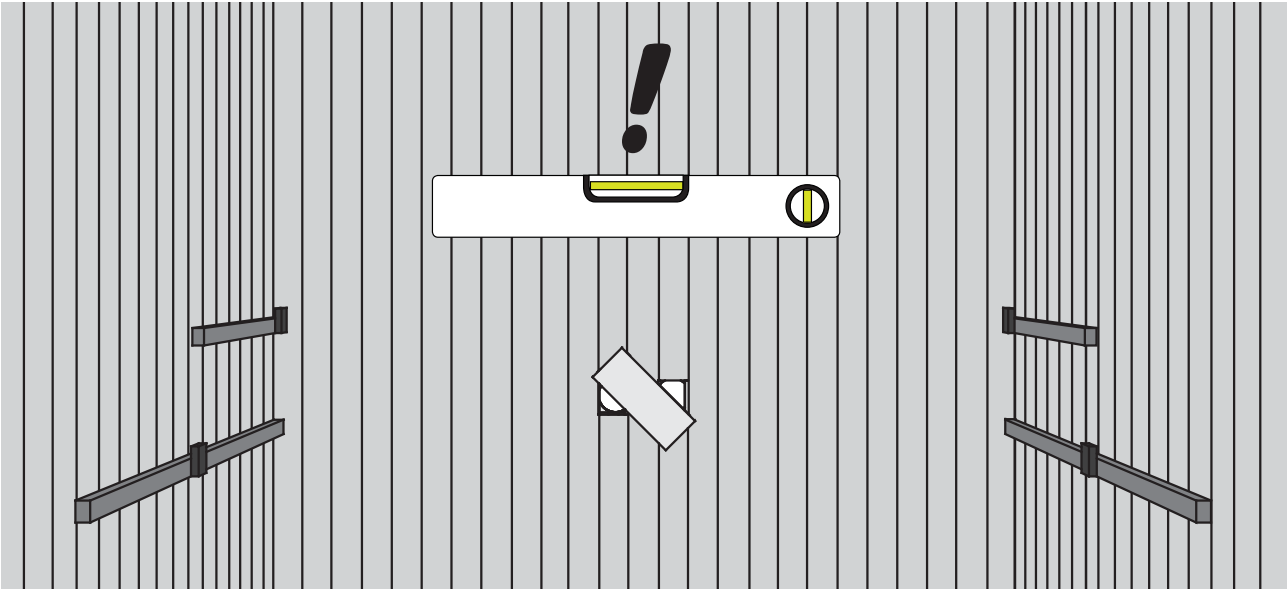

6x60

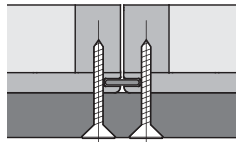

6x60

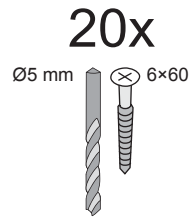

20x

Ø5 mm 6x60

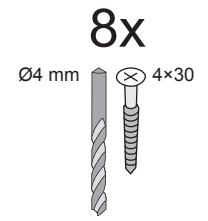

8x

Ø4 mm 4x30

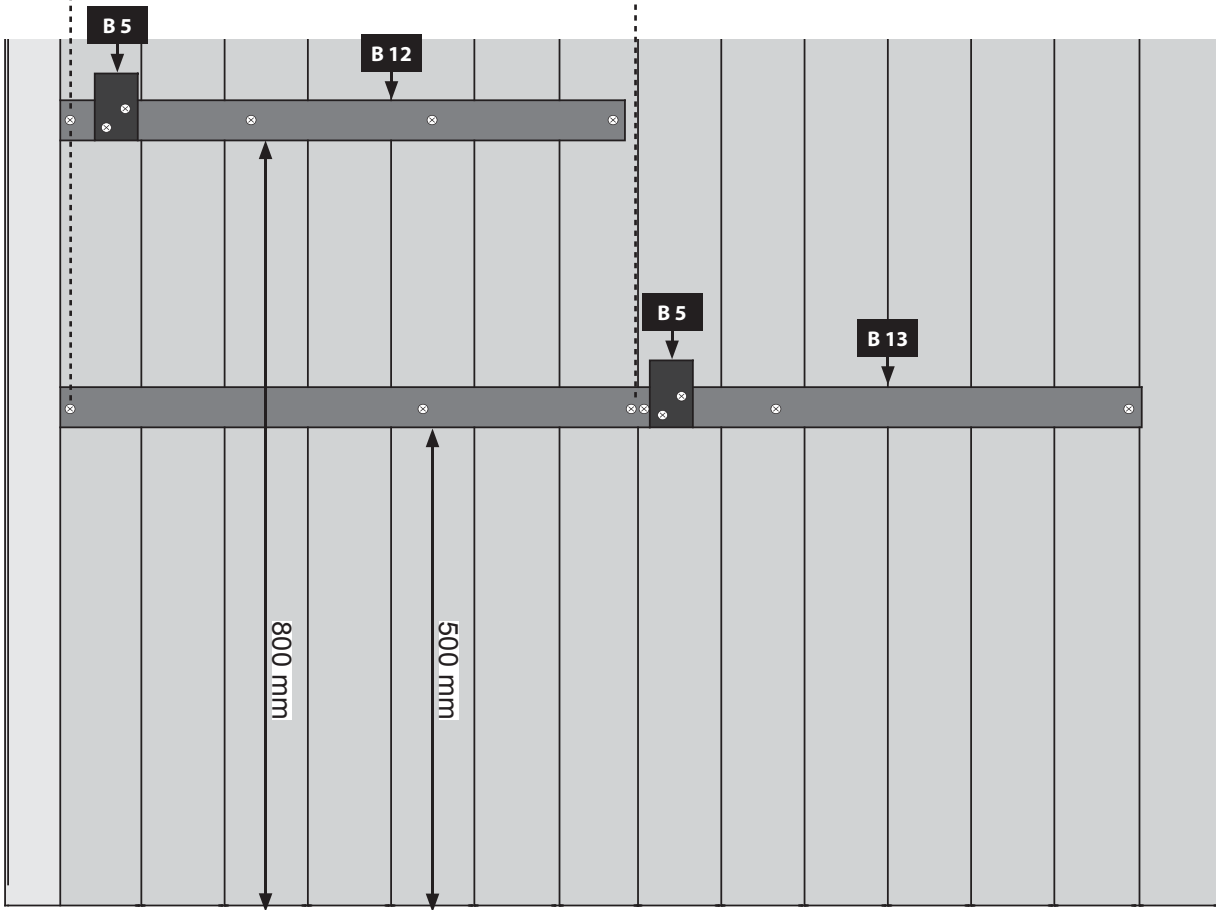

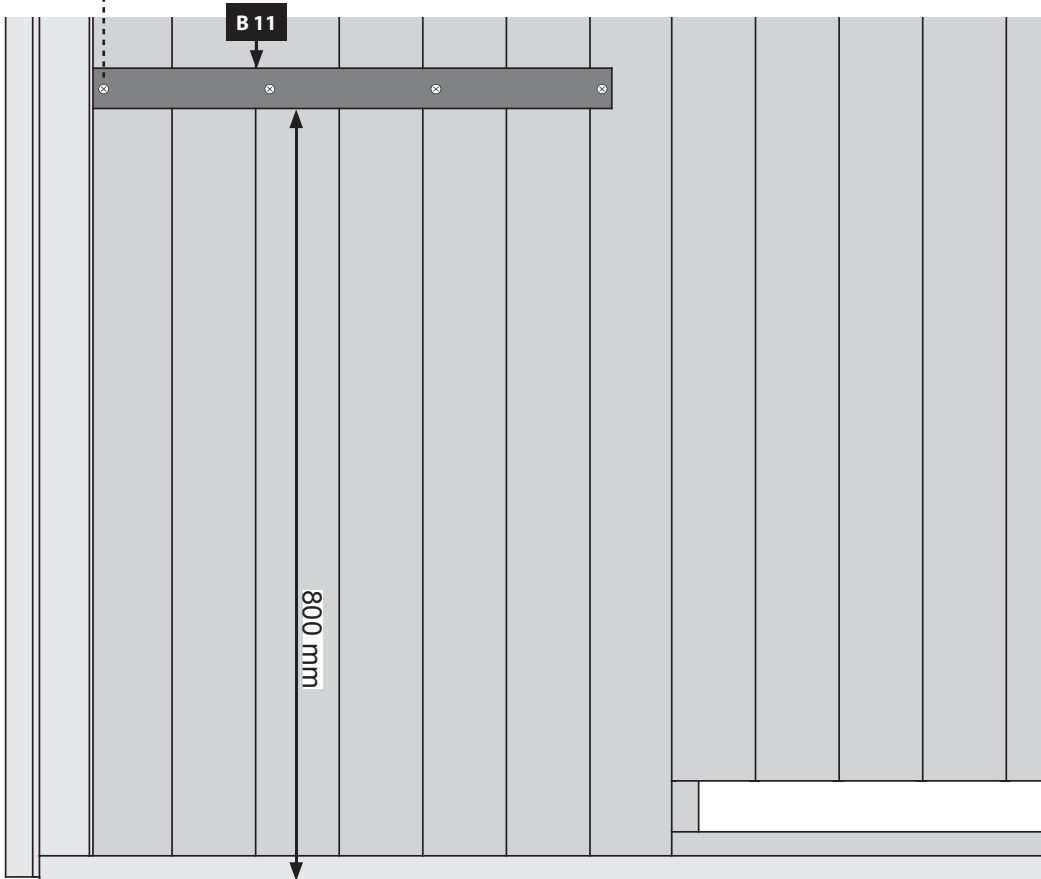
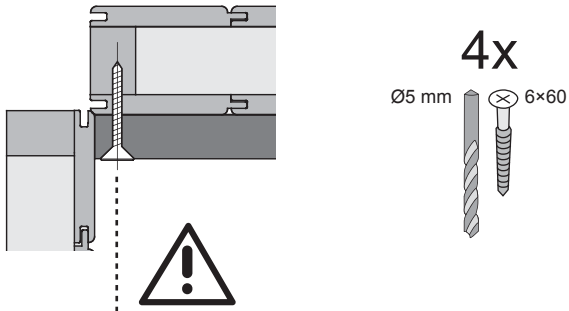
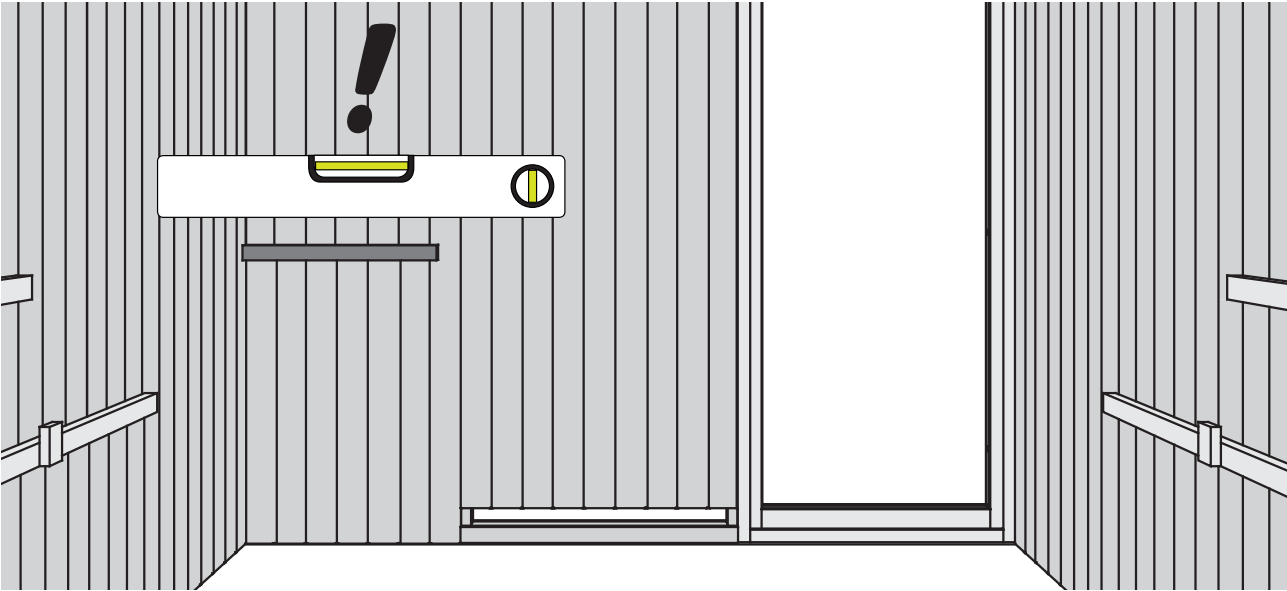

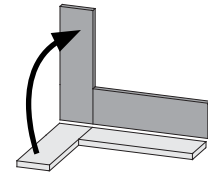
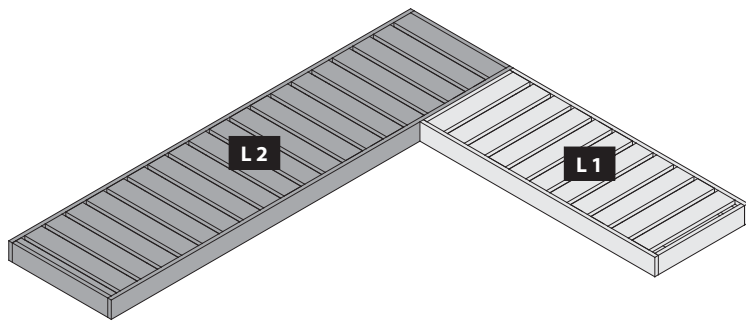

20

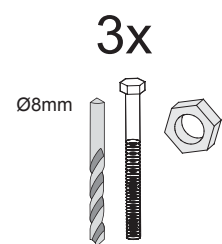
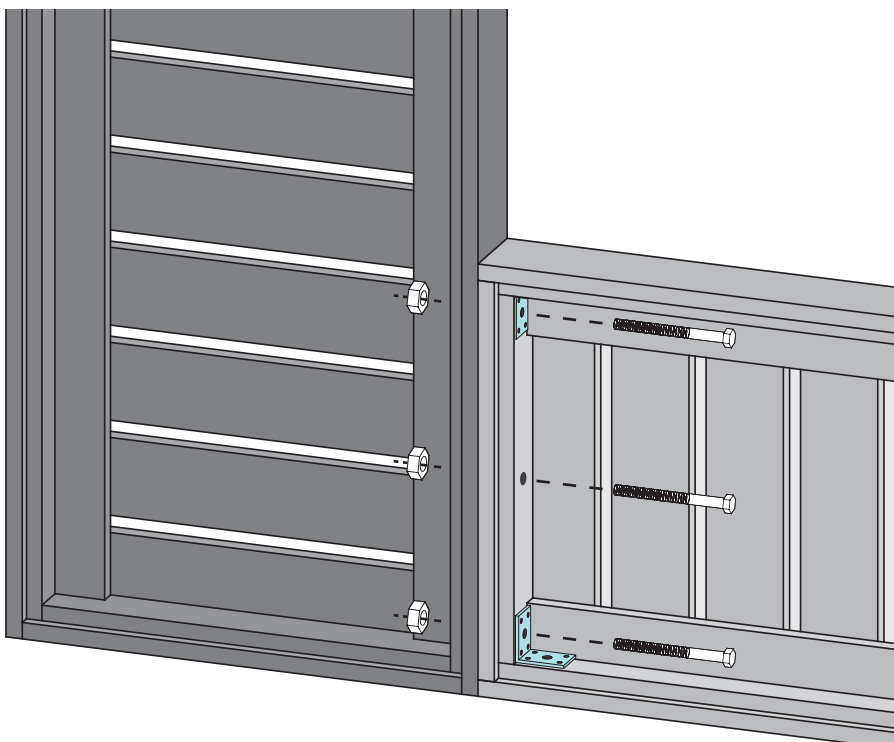
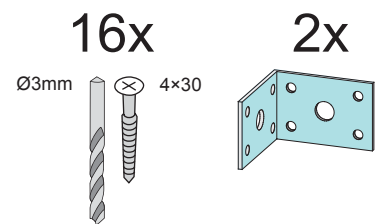
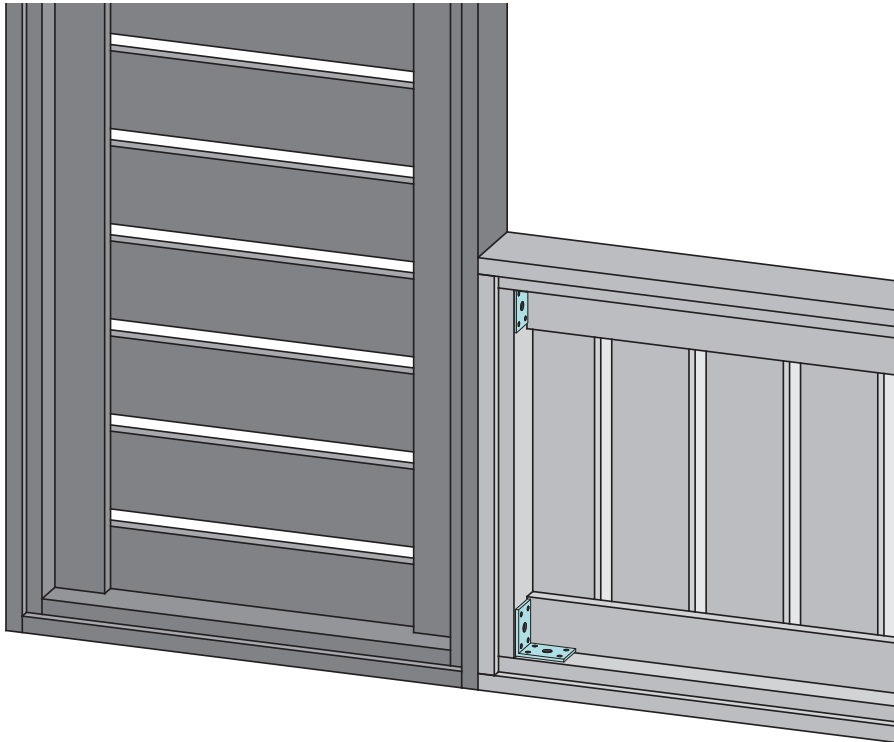



15x

Ø3mm 4x50

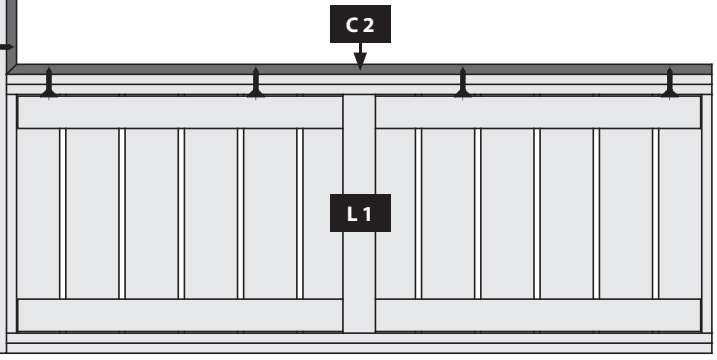
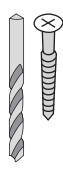

-  Ansicht unten
-  View below
-  Voir ci-dessous
-  Bekijk hieronder
-  Se nedenfor
-  Ver abajo
-  Visualizza sotto
-  Zobrazit níže

1.

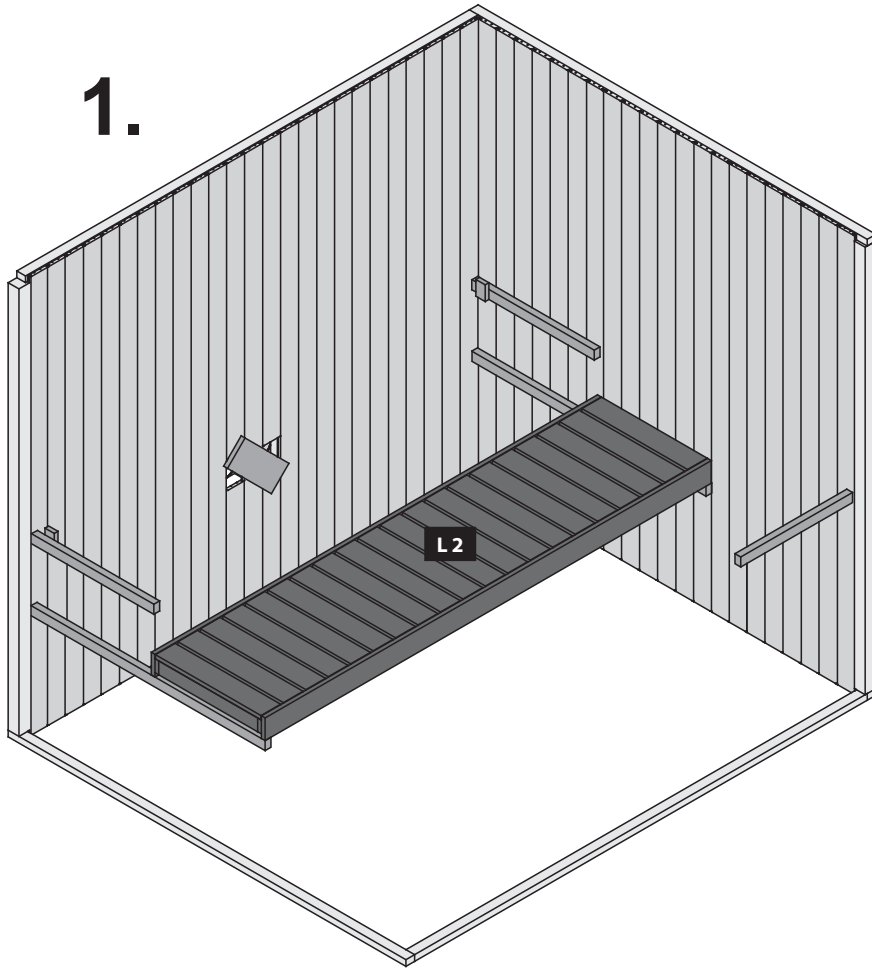

2.

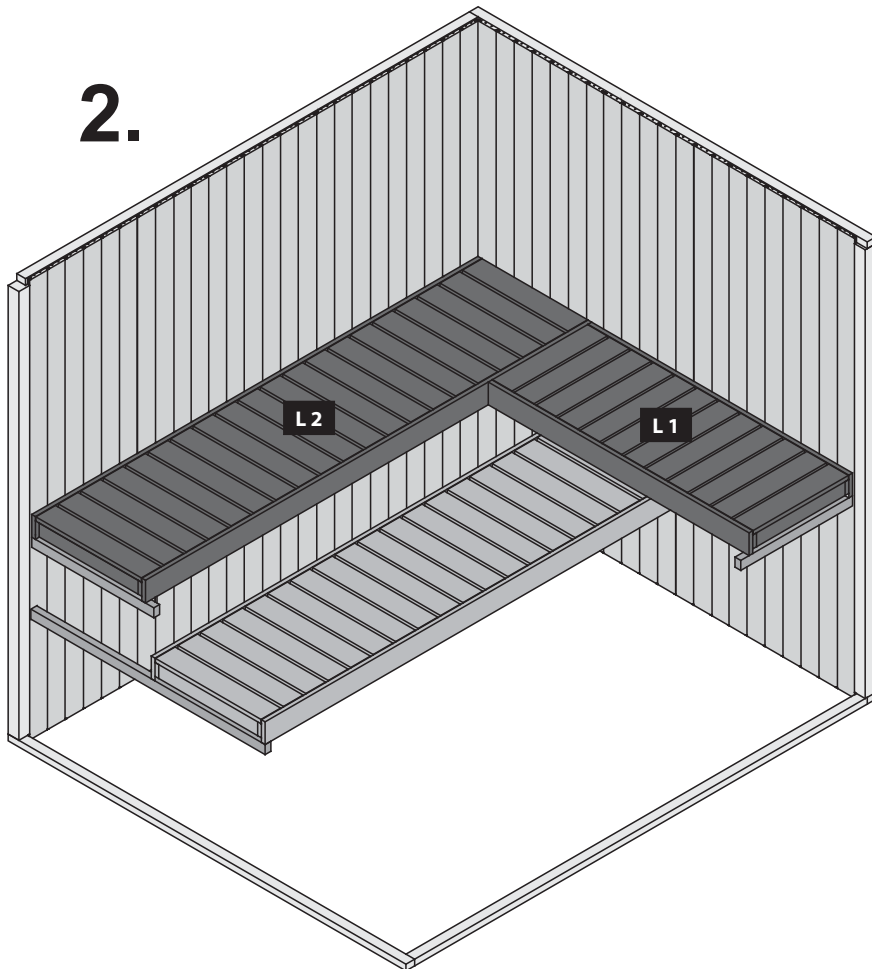

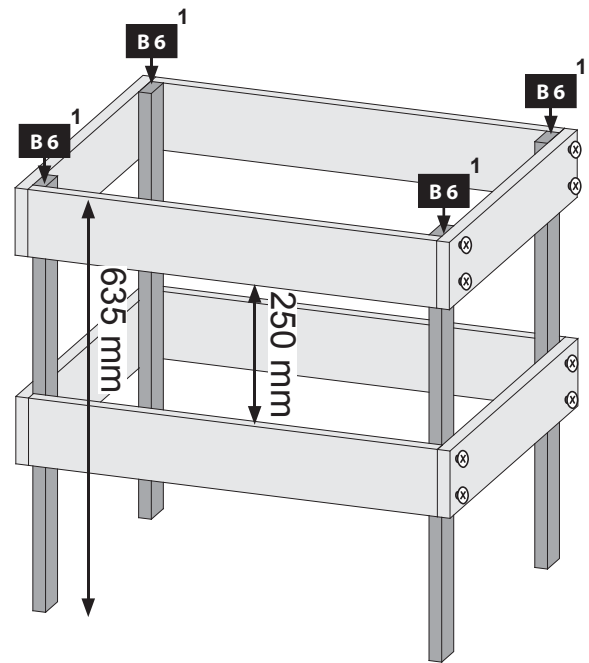
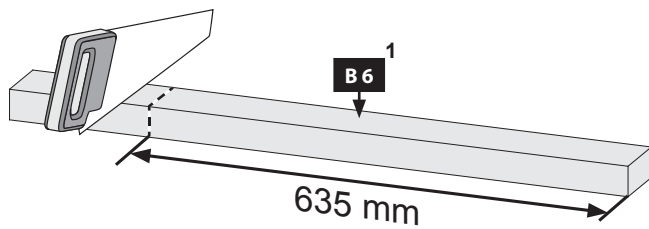
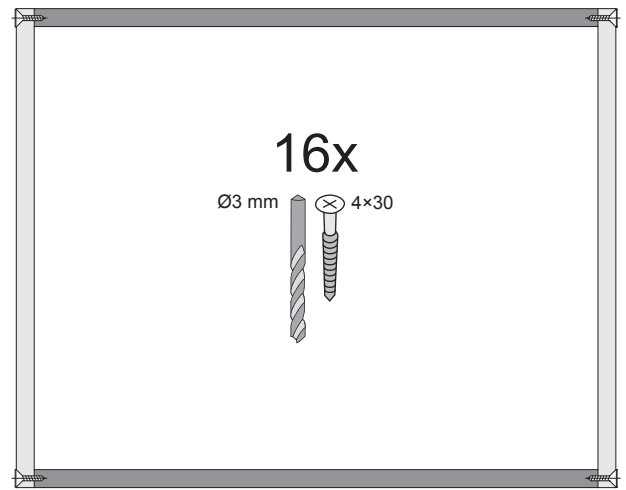
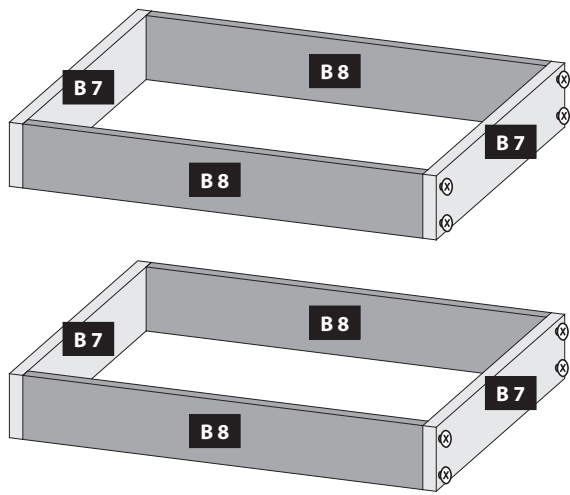

-  Nur bei 9 / 4,5 kW-Ofen
-  Only 9 / 4,5 kW heater
-  Seulement 9 / 4,5 kW chauffe
-  Kun ved 9 / 4,5 kW ovn
-  Slechts 9/4,5 kW heater
-  Sólo calentador de 9 / 4,5 kW
-  Solo riscaldamento 9 / 4,5 kW
-  Pouze topné těleso 9 / 4,5 kW

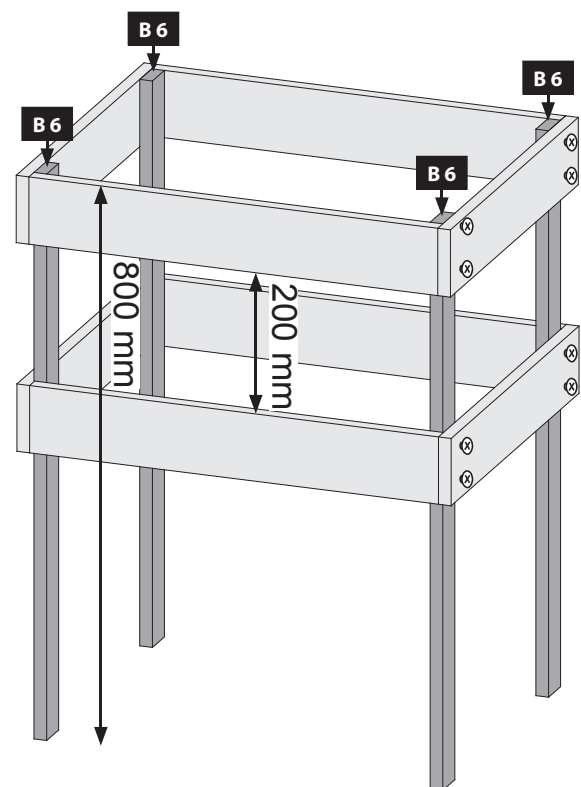
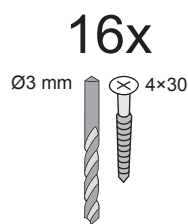

-  Bei allen anderen Öfen
-  For all other furnaces
-  Pour tous les autres fours
-  Kun ved 9 kW ovn
-  Voor alle andere ovens
-  Para todos los otros hornos
-  Per tutti gli altri tipi di forni
-  U všech ostatních pecích

Exemplarische Kabelverlegung

Saunatyp	68mm
Steuerung	extern

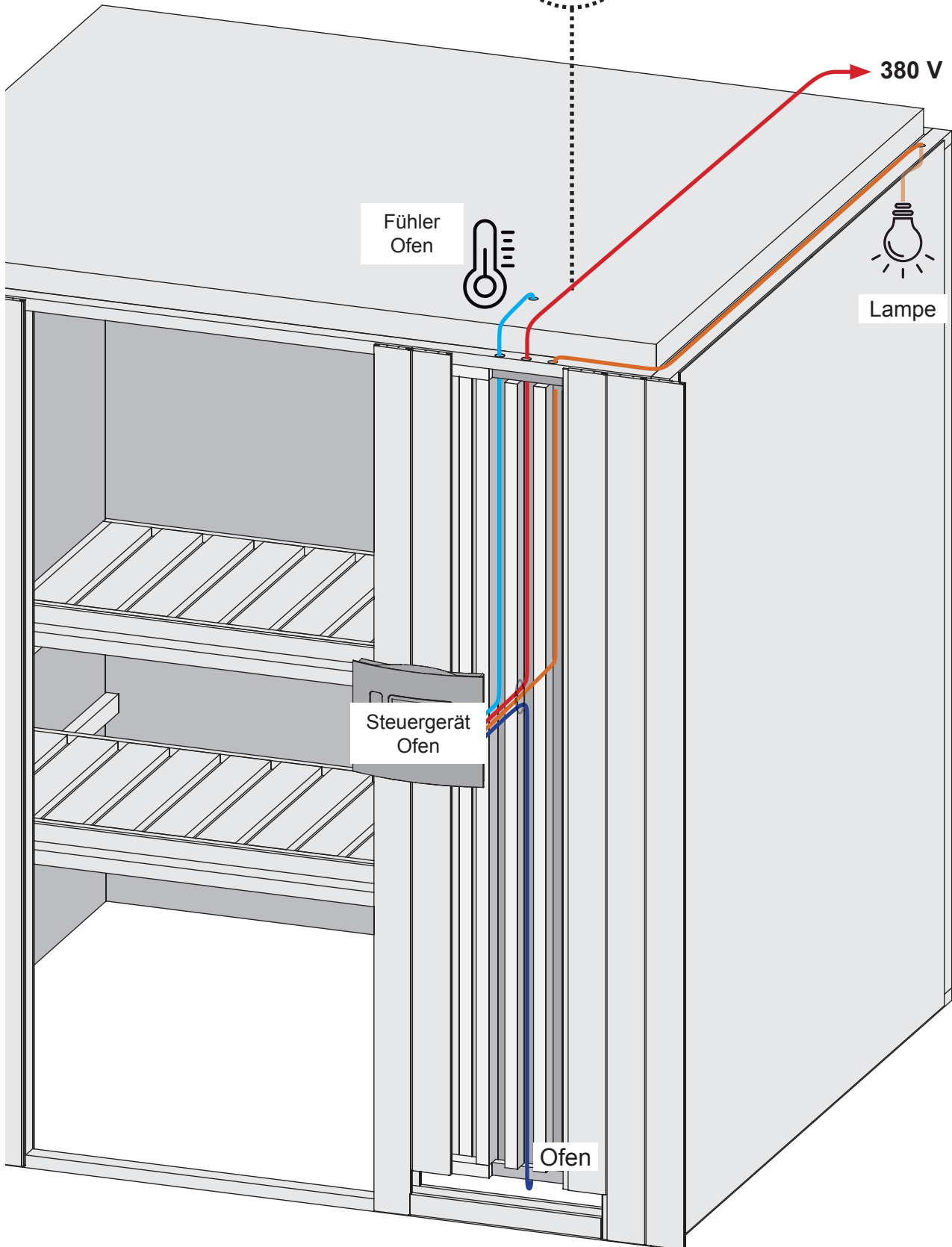
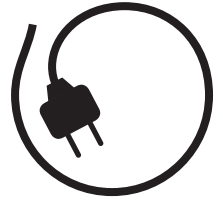
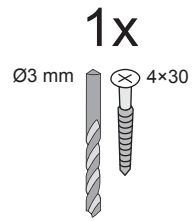

Exemplarische Kabelverlegung



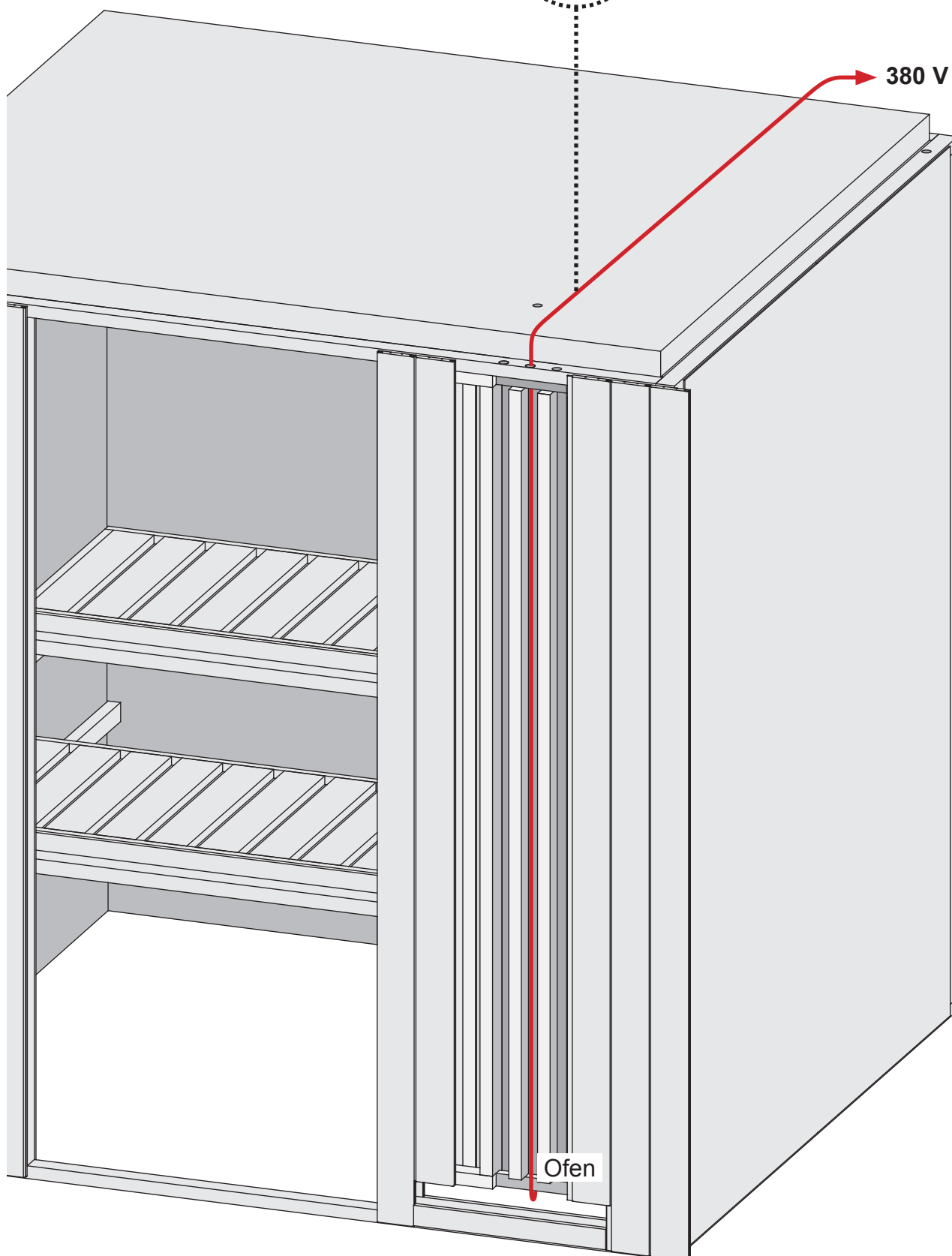
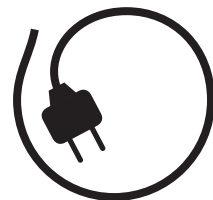
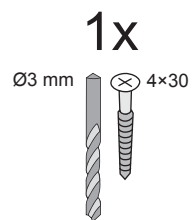

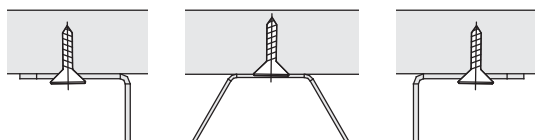
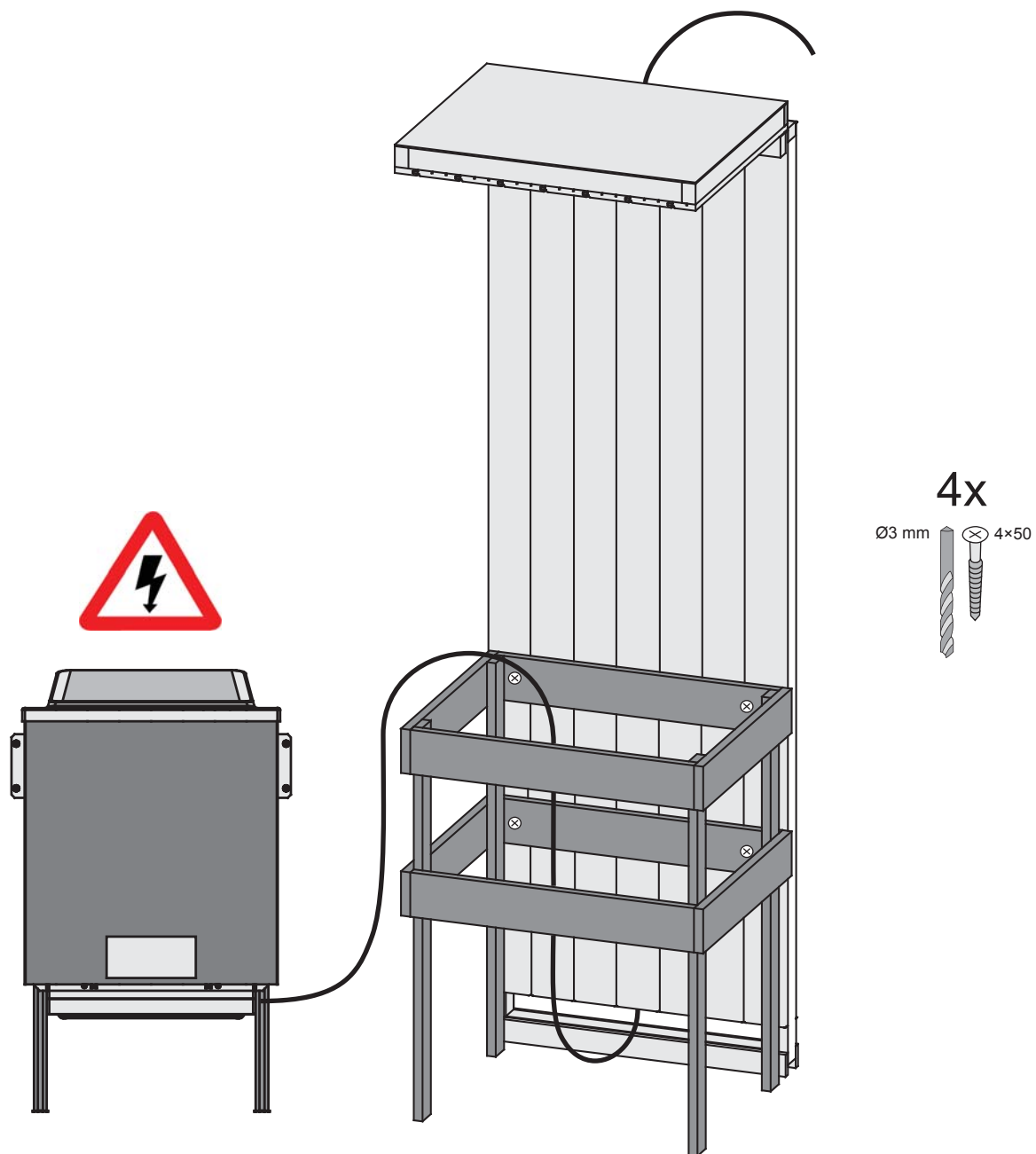
Saunatyp 68mm
Steuerung integriert



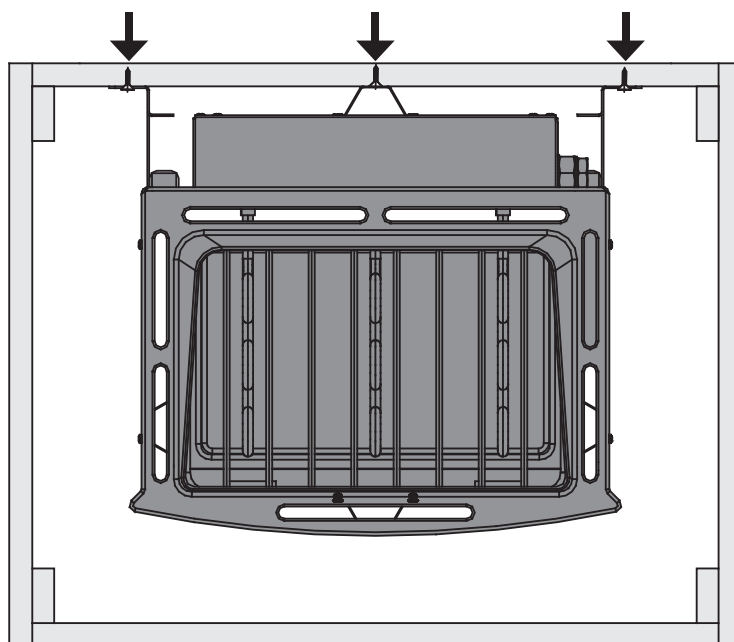





-  Ofenbefestigung
-  oven fixing
-  fixation four
-  oven vaststelling
-  oven fastsættelse
-  fijación horno
-  fissaggio forno
-  upevňovací trouba



-  Einbau Glastür
-  Installation of glass door
-  Montage porte en verre
-  Montage van de glazen deur

-  Installationsglasdør
-  Montaje de la puerta de cristal
-  Installazione portello di vetro
-  Sauna Instalace dveře

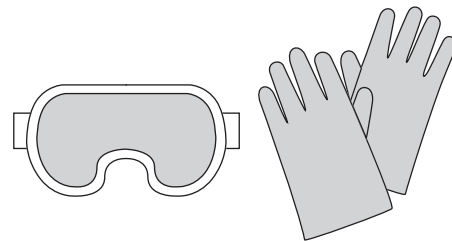



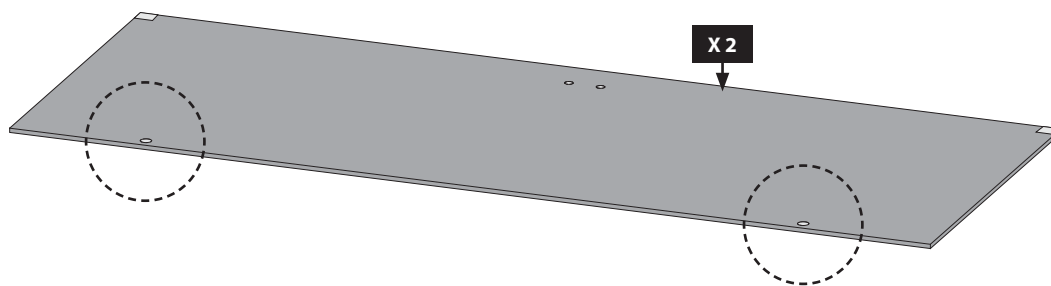
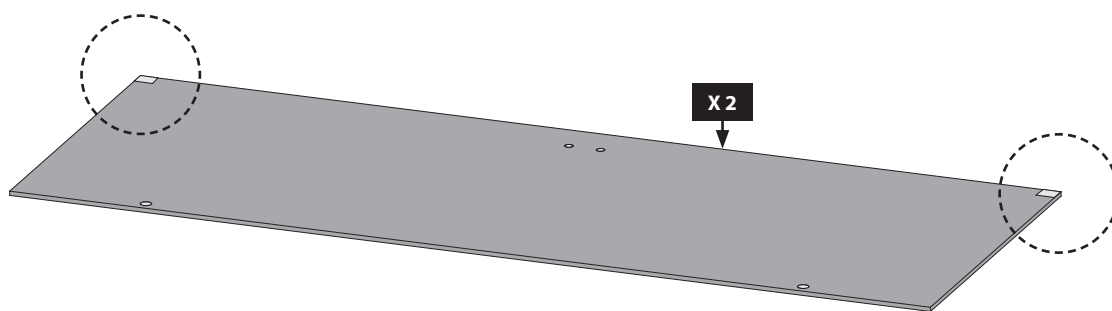
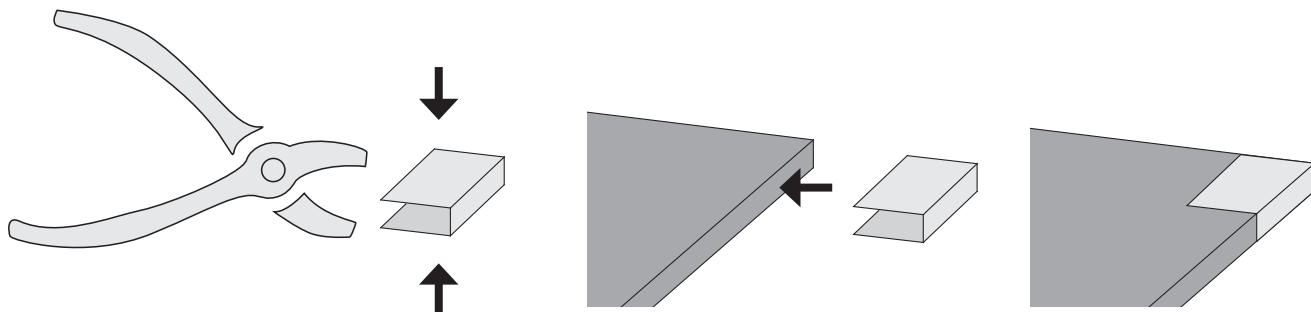



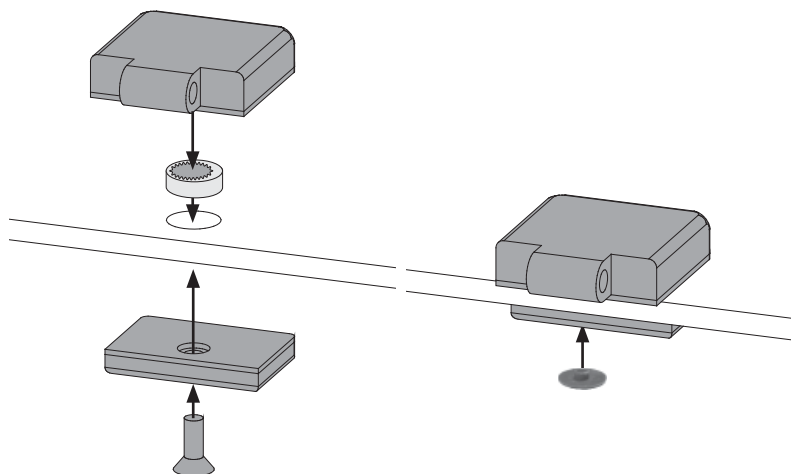

27







-  Alle Verstell-Excenter müssen in der Glasscheibe die gleiche Grundstellung haben
-  All adjustable eccentrics must have the same basic adjustment in the glass panel
-  Tous les excenteurs de positionnement doivent avoir la même position de base dans la vitre
-  Alle excentrische verstelelementen moeten in dezelfde stand in de glasplaat worden geplaatst
-  Alle justeringsexcenter skal have samme grundlæggende position i glasruden
-  Todos los excéntricos regulables tienen que tener la misma posición base en la hoja de cristal
-  Tutti gli eccentrici di regolazione devono avere la stessa posizione base nella lastra di vetro
-  šechny nastavovací podivínů musí mít stejný základní polohy ve skle



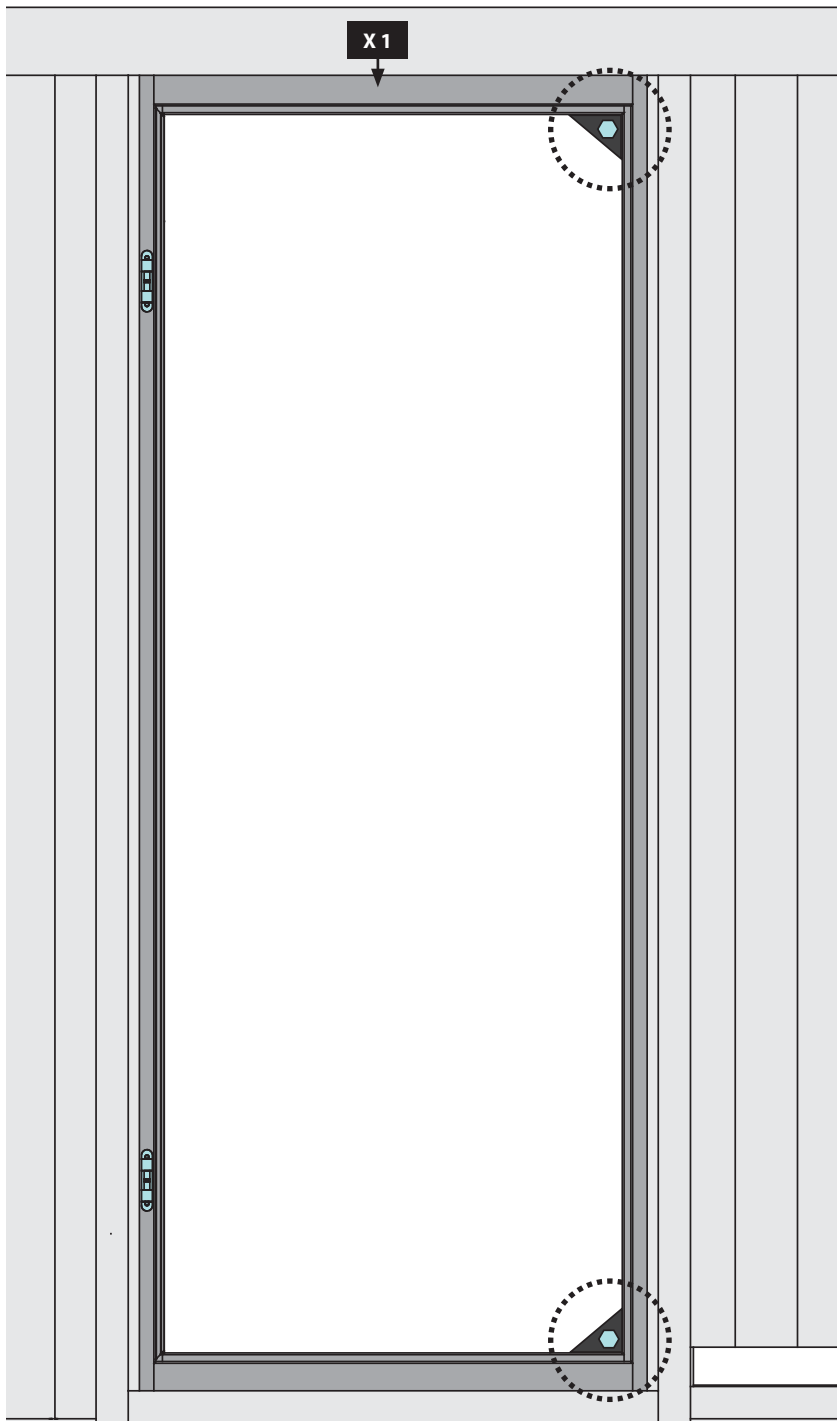
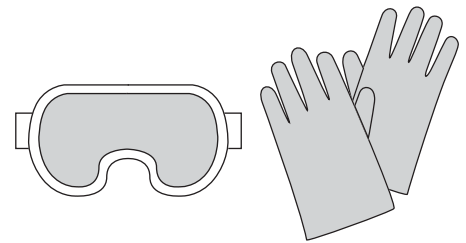



-  Einbau Glastür
-  Installation of glass door
-  Montage porte en verre
-  Montage van de glazen deur





-  Installationsglasdør
-  Montaje de la puerta de cristal
-  Installazione portello di vetro
-  Sauna Instalace dveře



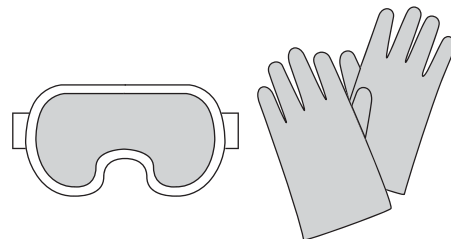



-  Einbau Glastür
-  Installation of glass door
-  Montage porte en verre
-  Montage van de glazen deur

-  Installationsglasdør
-  Montaje de la puerta de cristal
-  Installazione portello di vetro
-  Sauna Instalace dveře



-  Alle Verstell-Excenter müssen in der Glasscheibe die gleiche Grundstellung haben
-  All adjustable eccentrics must have the same basic adjustment in the glass panel
-  Tous les excentreurs de positionnement doivent avoir la même position de base dans la vitre
-  Alle excentrische verstelelementen moeten in dezelfde stand in de glasplaat worden geplaatst

-  Alle justeringsexcentricer skal have samme grundlæggende position i glasruden
-  Todos los excéntricos regulables tienen que tener la misma posición base en la hoja de cristal
-  Tutti gli eccentrici di regolazione devono avere la stessa posizione base nella lastra di vetro
-  šechny nastavovací podivínů musí mít stejný základní polohy ve skle

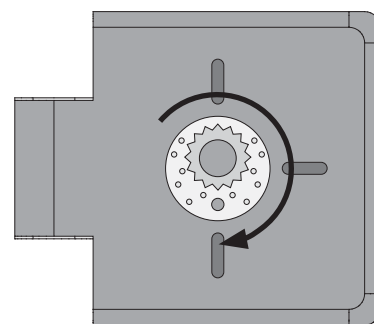
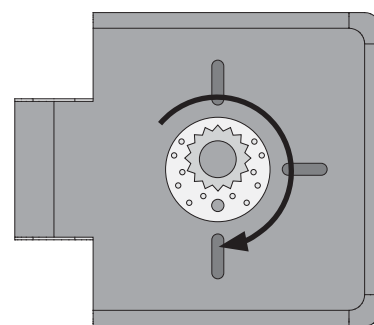
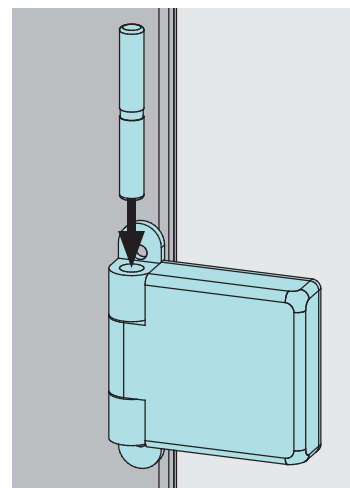
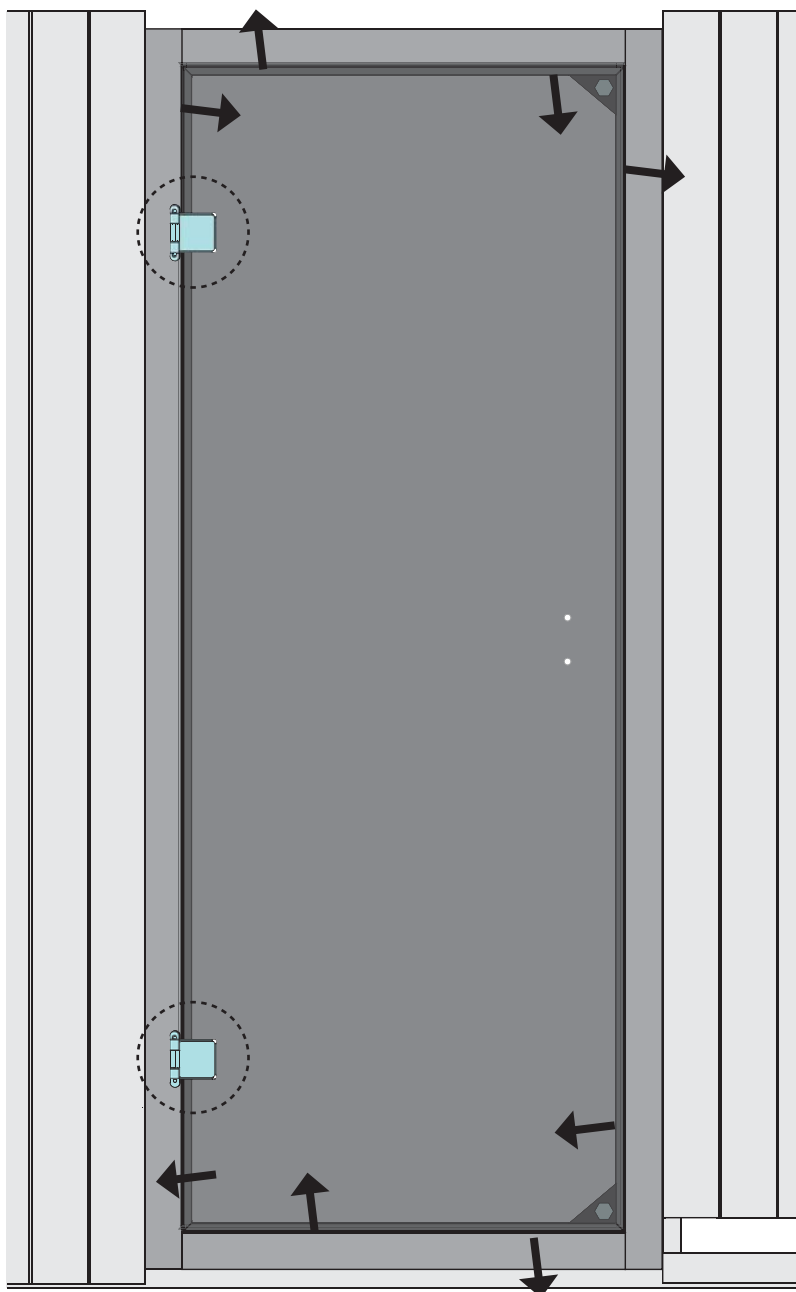

1.

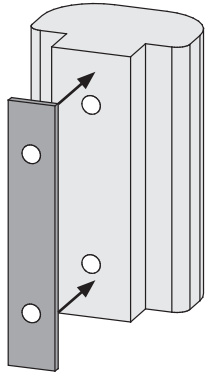

2.

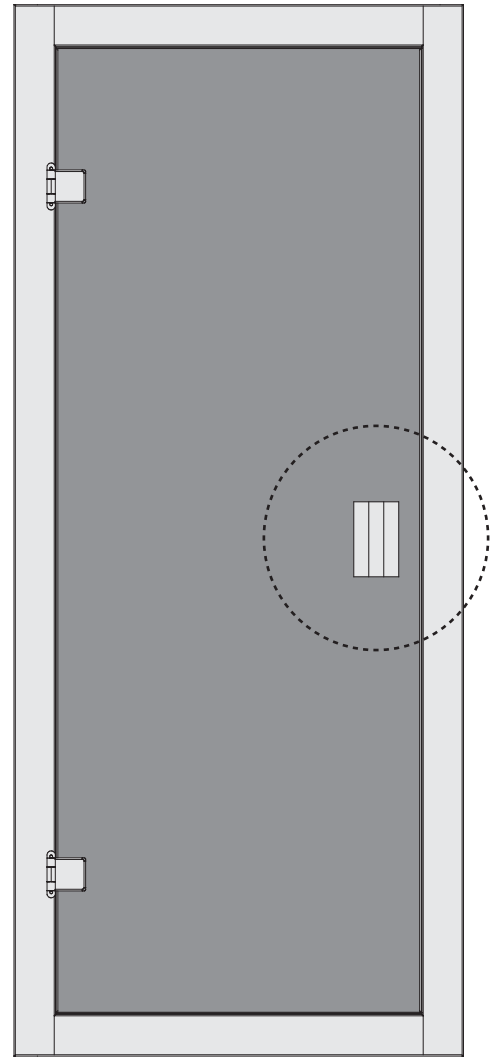
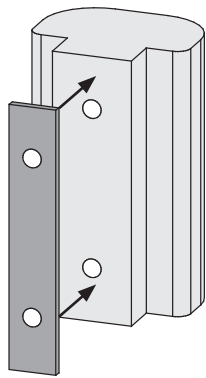

3.

